

PX 450

LINEAR
PORTE INTERNE

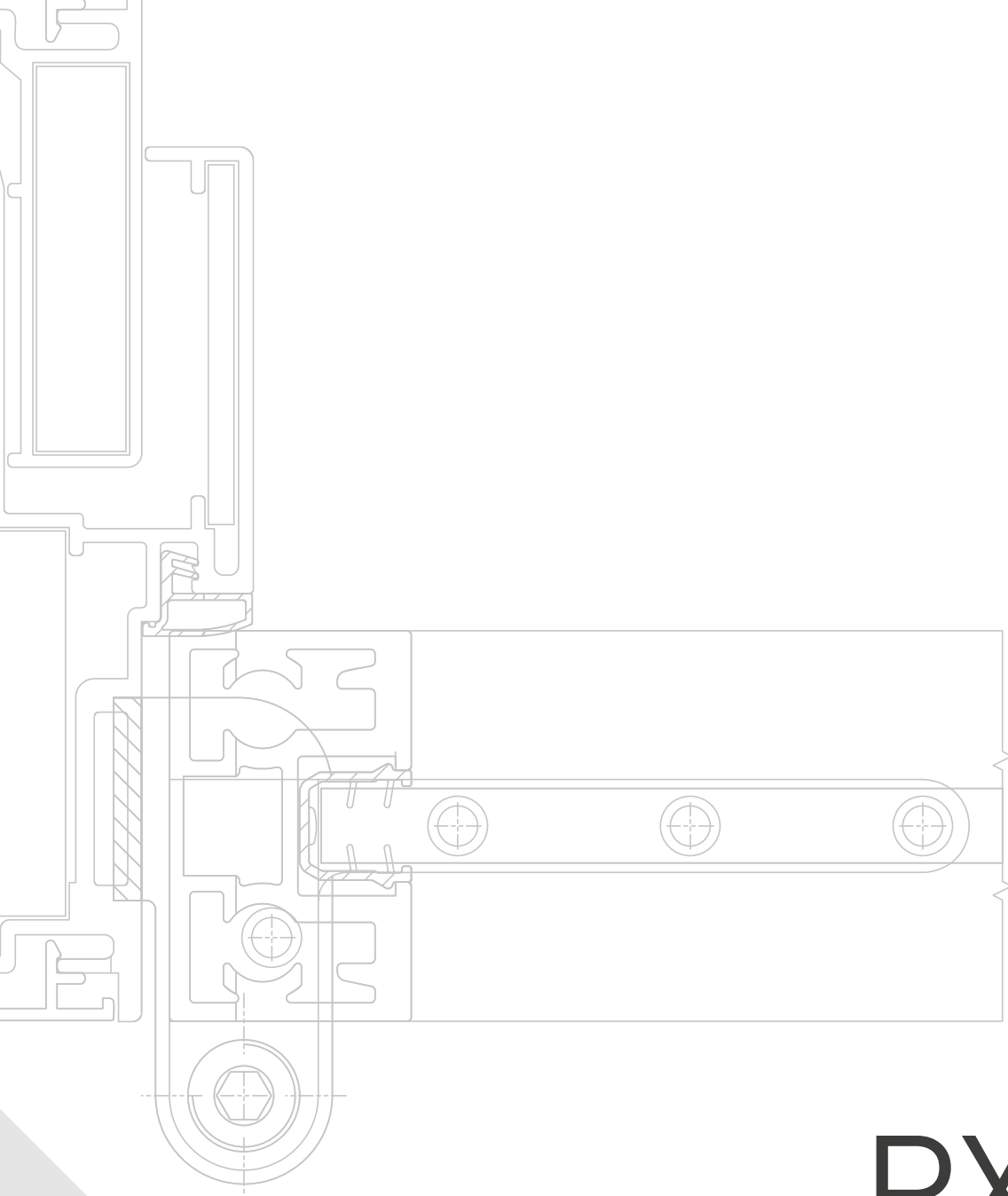



PX 450

LINEAR
PORTE INTERNE





Informazioni generali	Gruppo A	Indice generale Caratteristiche alluminio Descrizione tecnica sistema Descrizione tecnica capitolato Collaudi prestazionali
Profilati	Gruppo B	Elenco profilati Profilati scala 1.1
Accessori e Guarnizioni	Gruppo C	Elenco accessori Elenco guarnizioni
Sezioni	Gruppo D	Sezioni principali in scala 1:1 corredate dei relativi accessori
Tipologie	Gruppo E	Principali tipologie di porte
Collegamento muratura	Gruppo F	Sezione particolareggiata attacco alla muratura
Lavorazioni / Montaggi	Gruppo G	Schemi lavorazioni Frese Attrezzature



Porta Battente in alluminio

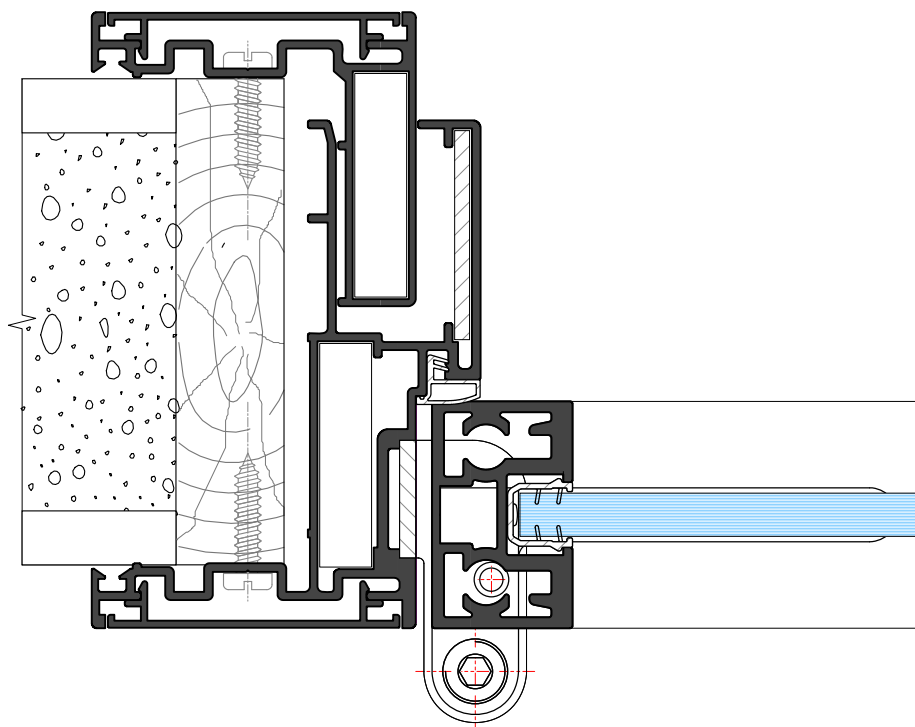

Profilati estrusi lega: ENAW 6060 (EN 573 - 3)
Stato di fornitura: T5 (EN 752 - 2)
Tolleranze dimensioni e spessori: EN 755 - 9

Tipo di tenuta : Battuta.
Inserimento del vetro : Ad infilare .

Dimensioni principali

Telaio fisso : secondo opera muraria
Telaio mobile: anta in alluminio da mm. 26 x 42
vetro singolo (altezza sede vetro mm.12.5)

Fuga perimetrale interna : mm. 3
Aletta sovraopposizione al muro: mm. 40
Giunzione angolare telaio ed anta: a 45° con squadrette tubolarità mm.10.4 x mm. 42.2
(telaio) e a 90° con accessori specifici (anta)

Impiego:
Profilati che consentono la costruzione di porte ad una o due ante a battente con sopra-luce.



Porta Battente in legno

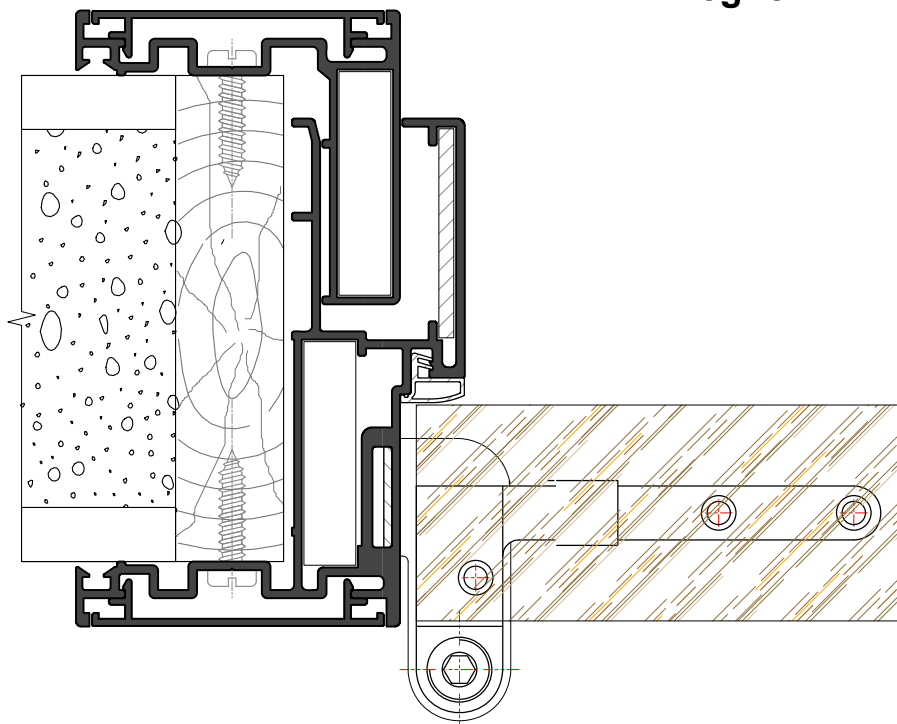

Profilati estrusi lega: ENAW 6060 (EN 573 - 3)
Stato di fornitura: T5 (EN 752 - 2)
Tolleranze dimensioni e spessori: EN 755 - 9
Battuta: Battuta.

Tipo di tenuta : .

Dimensioni principali

Telaio fisso : secondo opera muraria
Telaio mobile: anta in legno spessore mm. 40

Fuga perimetrale interna : mm. 3
Aletta sovraopposizione al muro: mm. 40
Giunzione angolare telaio ed anta: a 45° con squadrette tubolarità mm.10.4 x mm. 42.2 (telaio)

Impiego:
 Profilati che consentono la costruzione di porte ad una o due ante a battente con sopra-luce.



Porta Battente in vetro

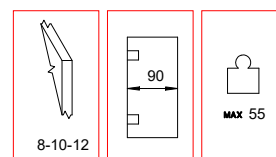
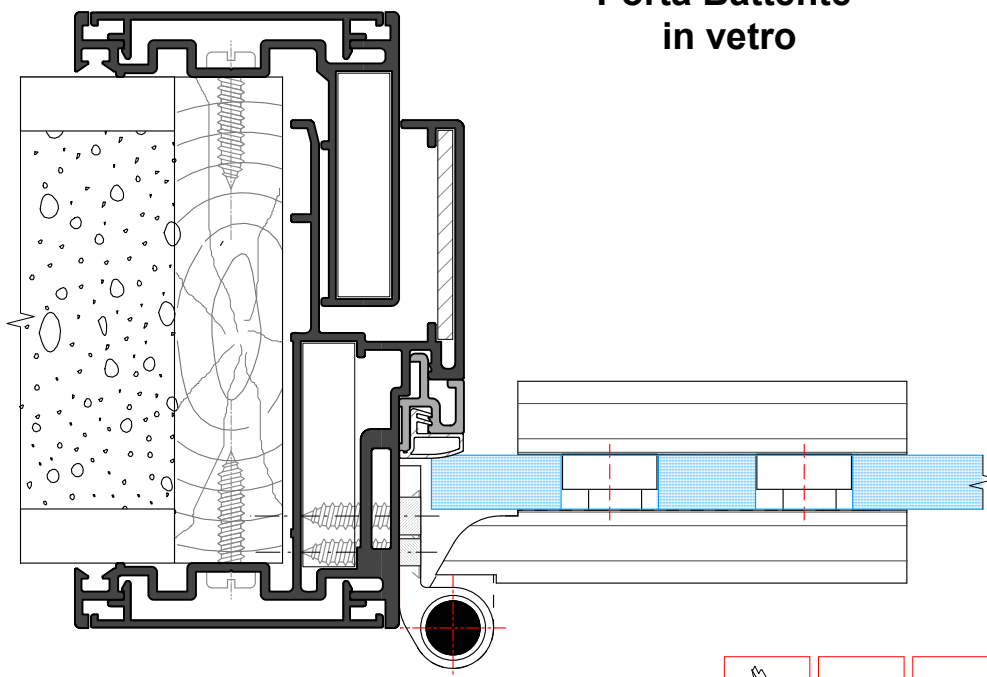

Profilati estrusi lega: ENAW 6060 (EN 573 - 3)
Stato di fornitura: T5 (EN 752 - 2)
Tolleranze dimensioni e spessori: EN 755 - 9
Tipo di tenuta : Battuta.

Dimensioni principali

Telaio fisso : secondo opera muraria
Telaio mobile: anta in vetro spessore mm. 8-10-12
Fuga perimetrale interna : mm. 3
Aletta sovraopposizione al muro: mm. 40
Giunzione angolare telaio ed anta: a 45° con squadrette tubolarità mm.10.4 x mm. 42.2 (telaio)

Impiego:
 Profilati che consentono la costruzione di porte ad una o due ante a battente con sopra lucce.



Porta Scorrevole a Scomparsa

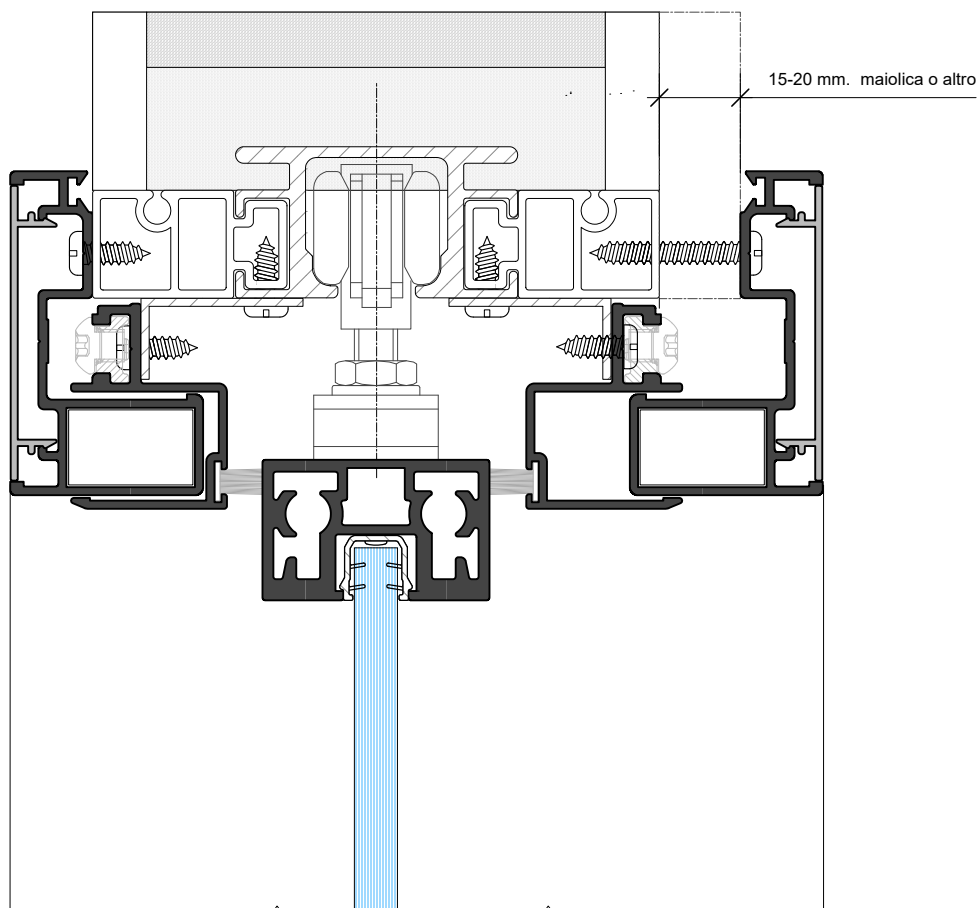

Profilati estrusi lega: ENAW 6060 (EN 573 - 3)
Stato di fornitura: T5 (EN 752 - 2)
Tolleranze dimensioni e spessori: EN 755 - 9

Tipo di tenuta : con spazzolini.
Inserimento del vetro : Ad infilare .

Dimensioni principali

Telaio fisso : secondo opera muraria
Telaio mobile: anta in alluminio da mm. 26(90) x 42 con pannello di legno
 anta in alluminio da mm. 26(90) x 42 con vetro singolo o doppio
 anta in legno da mm. 40

Controtelaio : tipo "Scrigno base 105 mm" per intonaco
Aletta sovraopposizione al muro: mm. 25 (controtelaio)
Giunzione angolare telaio ed anta: a 45° con squadrette tubolarità mm.10.4 x mm. 42.2
 (telaio) e a 90° con accessori specifici (anta)

Impiego:
 Profilati che consentono la costruzione di porte ad una o due ante a scomparsa.



PX45.102			Tavola 02
Telaio porta			
Peso	kg/ml.	1.700	
Jx 000.00 cm4	Wx 000.00 cm3		
Jy 000.00 cm4	Wy 000.00 cm3		

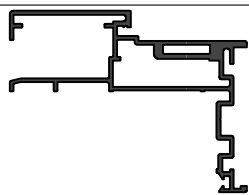

PX45.815			Tavola 04
Profilo battuta lat. scorrevole			
Peso	kg/ml.	0.932	
Jx 00.00 cm4	Wx 0.00 cm3		
Jy 00.00 cm4	Wy 0.00 cm3		

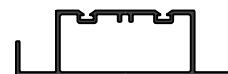

PX45.207			Tavola 02
Anta da mm. 26			
Peso	kg/ml.	1.250	
Jx 000.00 cm4	Wx 000.00 cm3		
Jy 000.00 cm4	Wy 000.00 cm3		



PX45.816			Tavola 04
Cartella coprivite per PX45.813			
Peso	kg/ml.	0.270	
Jx 000.00 cm4	Wx 000.00 cm3		
Jy 000.00 cm4	Wy 000.00 cm3		



PX45.208			Tavola 02
Anta da mm. 90			
Peso	kg/ml.	2.093	
Jx 000.00 cm4	Wx 000.00 cm3		
Jy 000.00 cm4	Wy 000.00 cm3		



PX45.818			Tavola 04
Imbotte per porta scorrevole			
Peso	kg/ml.	0.742	
Jx 00.00 cm4	Wx 0.00 cm3		
Jy 00.00 cm4	Wy 0.00 cm3		

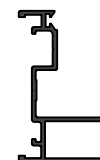

PX45.209			Tavola 03
Anta per doppio vetro			
Peso	kg/ml.	0.882	
Jx 00.00 cm4	Wx 0.00 cm3		
Jy 00.00 cm4	Wy 0.00 cm3		



PX45.820			Tavola 02
Imbotte per porta			
Peso	kg/ml.	0.799	
Jx 000.00 cm4	Wx 000.00 cm3		
Jy 000.00 cm4	Wy 000.00 cm3		

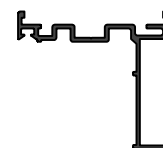

PX45.304			Tavola 03
Riparto centrale			
Peso	kg/ml.	0.760	
Jx 00.00 cm4	Wx 0.00 cm3		
Jy 00.00 cm4	Wy 0.00 cm3		



PX45.405			Tavola 03
Fascia da mm.90			
Peso	kg/ml.	1.722	
Jx 00.00 cm4	Wx 0.00 cm3		
Jy 00.00 cm4	Wy 0.00 cm3		



PX45.502			Tavola 03
Riduttore telaio per anta a vetro			
Peso	kg/ml.	0.190	
Jx 0.00 cm4	Wx 0.00 cm3		
Jy 0.00 cm4	Wy 0.00 cm3		



PX45.814			Tavola 04
Compensatore porta scorrevole			
Peso	kg/ml.	0.408	
Jx 000.00 cm4	Wx 000.00 cm3		
Jy 000.00 cm4	Wy 000.00 cm3		



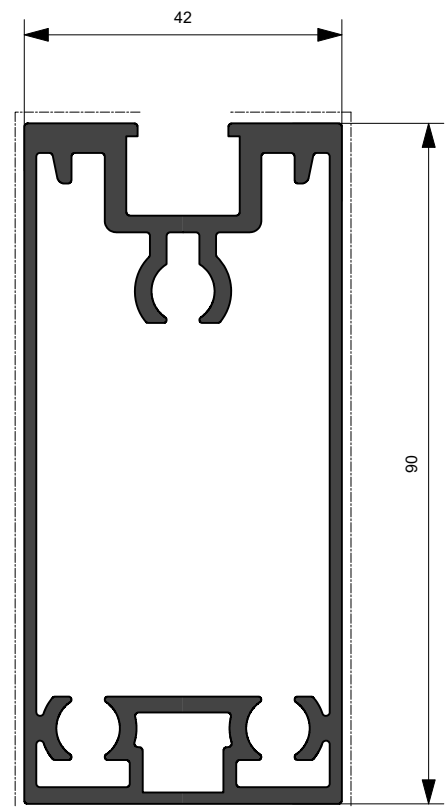
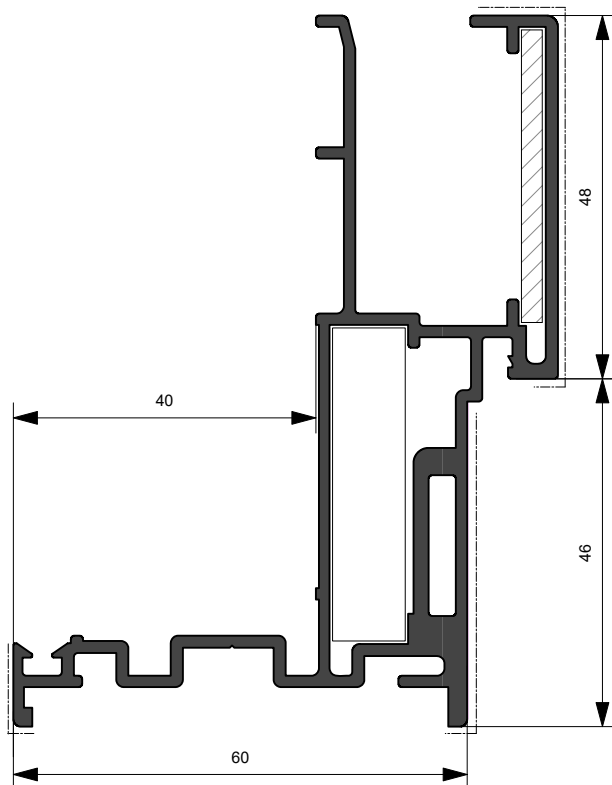
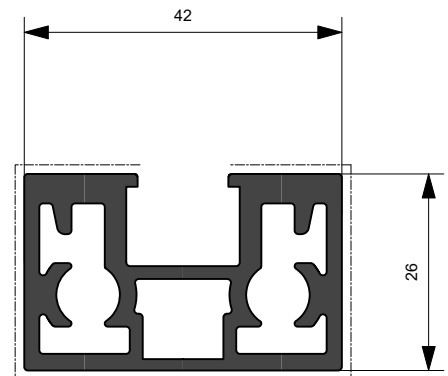
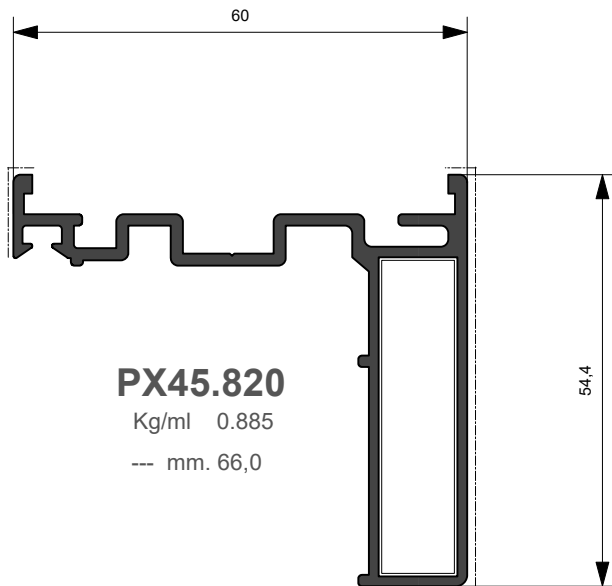

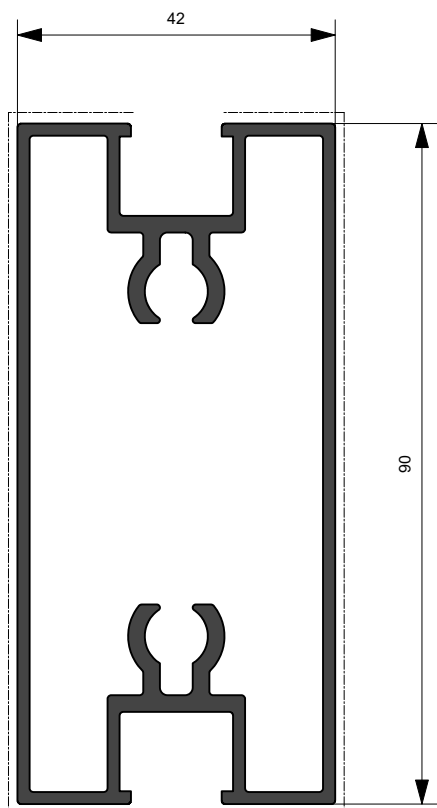

PX45.405

Kg/ml 1.722
--- mm. 240,0

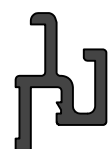

PX45.502

Kg/ml 0.190
--- mm. 10,0

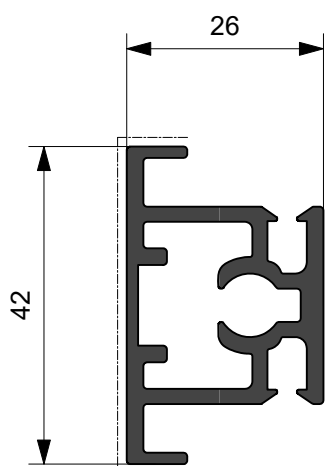

PX45.209

Kg/ml 0.882
--- mm. 58,0

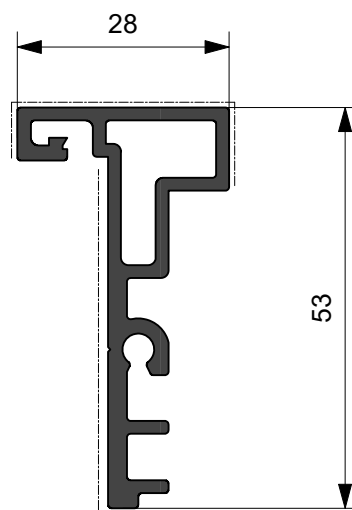

PX45.304

Kg/ml 0.760
--- mm. 92,0



Porte scorrevoli a scomparsa

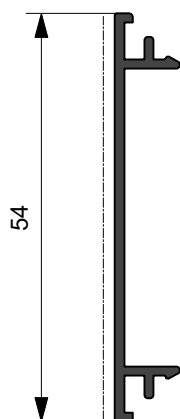

PX45.816

Kg/ml 0.270
--- mm. 54,0

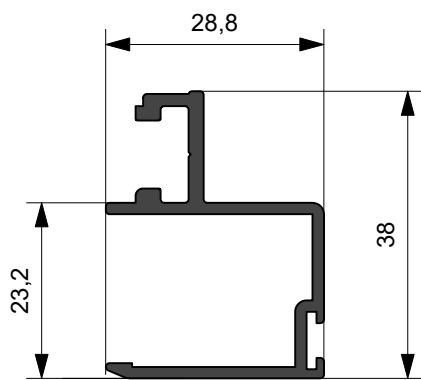

PX45.814

Kg/ml 0.408
--- mm. 29,0

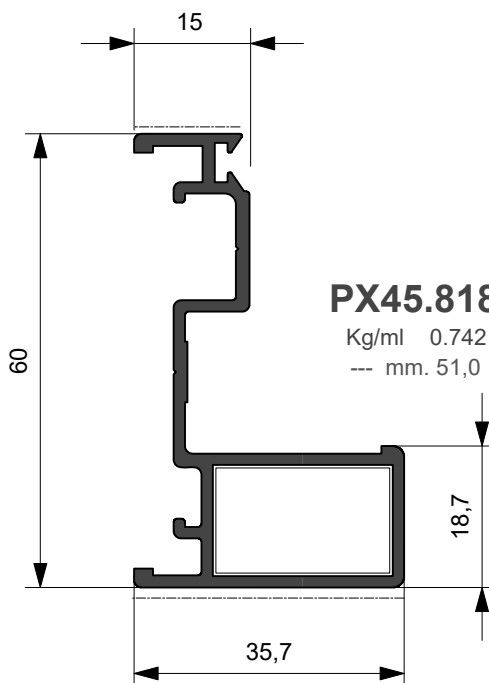

PX45.818

Kg/ml 0.742
--- mm. 51,0

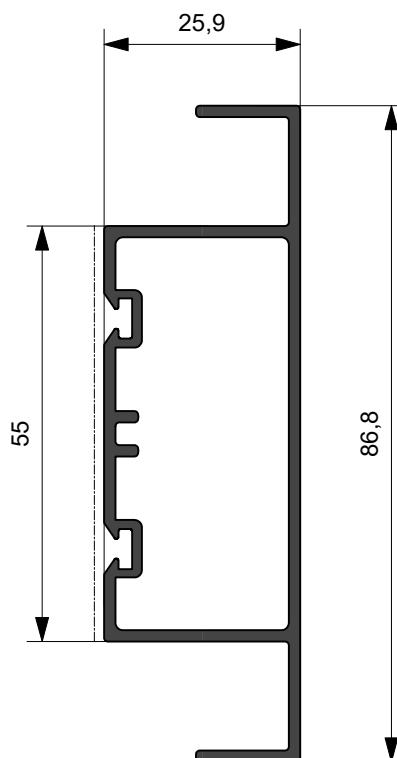



PX45.815

Kg/ml 0.932
--- mm. 55,0



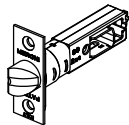

ARX.11.SQ	
Descrizione Squadretta allineamento su profilo PX45.814	
Materiale Zama	

APX.03.02	
Descrizione Scrocco tubolare rettangolare Interasse 80 mm.	

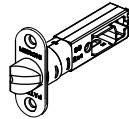
ARX.13.SQ	
Descrizione Squadretta a pulsante (23.5 mm x 14.5 mm)	
Materiale Zama	

APX.03.03	
Descrizione Scrocco tubolare ovale Interasse 80 mm.	

ARX.26.SQ	
Descrizione Squad. a pulsante per PX45.102-.820 (40.8mm x 9.9mm) Punzone Comm. Erre	

APX.03.04	
Descrizione Sottobordo in acciaio	
Materiale Acciaio	

APX.30.SQ	
Descrizione Tirante fissaggio ante	
Materiale Acciaio	

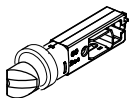
APX.03.15	
Descrizione Maniglia doppia in ottone con set canotti in acciaio 60 mm, senza contropiastra.	

APX.31.SQ	
Descrizione Vite per tirante fissaggio ante	
Materiale Acciaio	

APX.03.10	
Descrizione	

APX.02.05	
Descrizione Cerniera a filo per anta in alluminio o legno DX	
Materiale Acciaio	

APX.03.11	
Descrizione Adattatore in alluminio per maniglia doppia APX 03.10, su porte a vetro	

APX.02.06	
Descrizione Cerniera a filo per anta in alluminio o legno SX	
Materiale Acciaio	

APX.03.12	
Descrizione Contropiastra per APX 03.10	



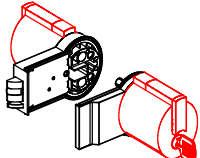

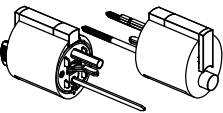

APX.02.07	
Descrizione Cerniera per porta a vetro	
Materiale Alluminio	

APX.03.13	
Descrizione Serratura con scrocco per porta a vetro da utilizzarsi assieme a APX.03.01	

APX.03.01	
Descrizione Pomolo di chiusura	

APX.03.14	
Descrizione Adattatore su profilo PX45.207 utilizzarsi assieme a APX.03.01	



<p>APX.03.15</p> <p>Descrizione</p> <p>Serratura per porta in legno con scrocco nascosto</p>		
<p>APX.03.16</p> <p>Descrizione</p> <p>Incontro magnetico per serratura APX.03.16</p>		
<p>ARX.10.07</p> <p>Descrizione</p> <p>Guarnizione da mm. 1</p>		
<p>APX.10.46</p> <p>Descrizione</p> <p>Guarnizione battuta porta Linear</p>		
<p>APX.10.49</p> <p>Descrizione</p> <p>Guarnizione trasparente vetro anta Linear</p>		
<p>ASX.10.36</p> <p>Descrizione</p> <p>Spazzolino base 6.9 mm. con pinna singola</p>		



Linear

PORTA INTERNA
con anta in alluminio e vetro

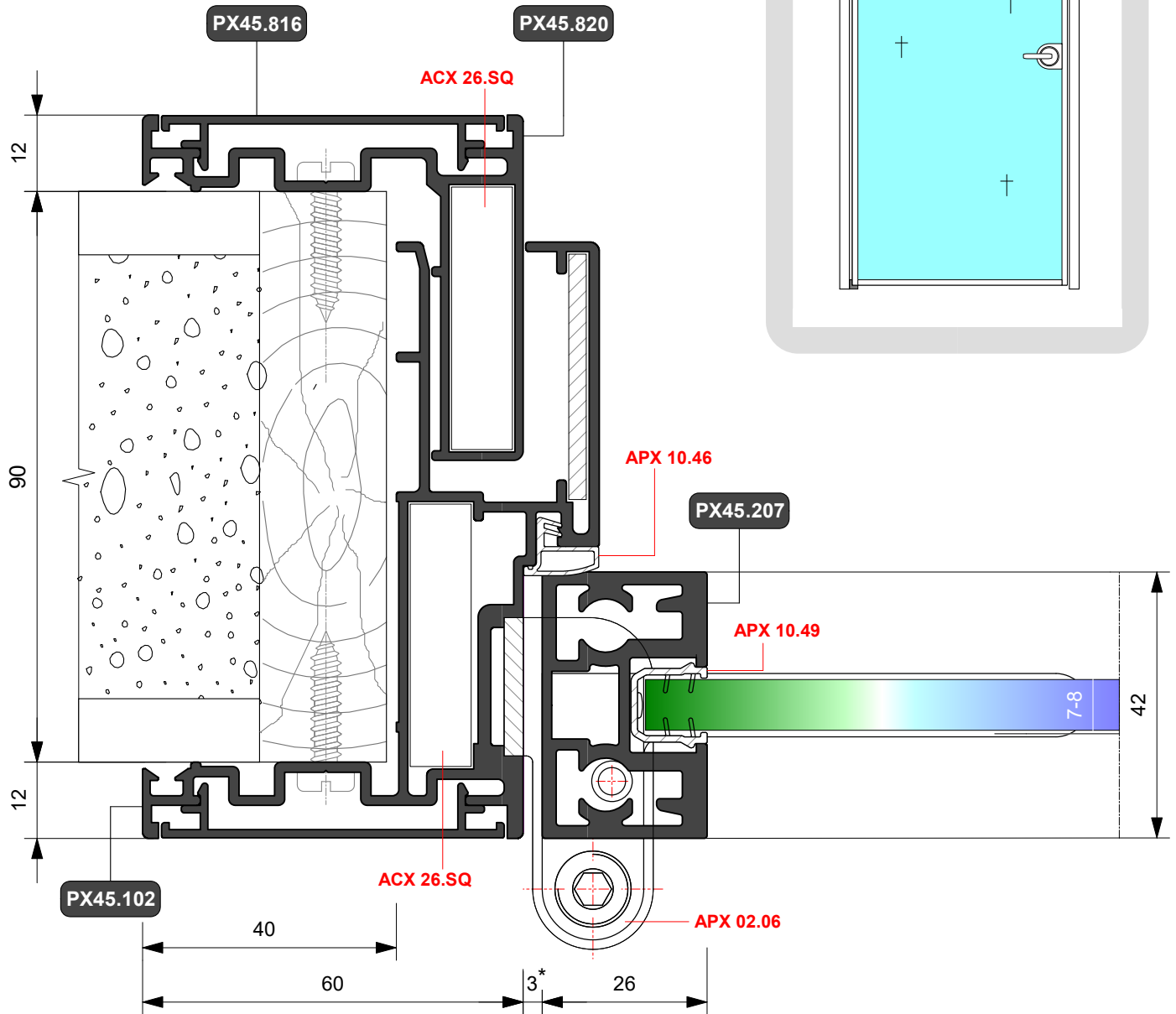
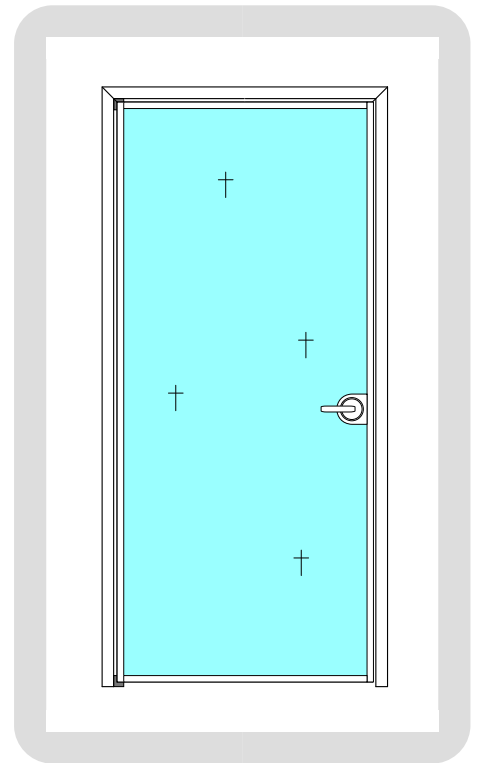

Variante con finitura in legno

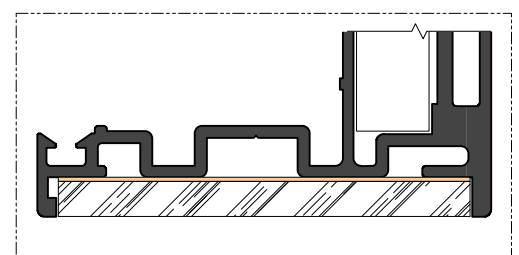

* Tolleranza +1 - 0 mm.



Linear

PORTA INTERNA
con anta in alluminio e vetro

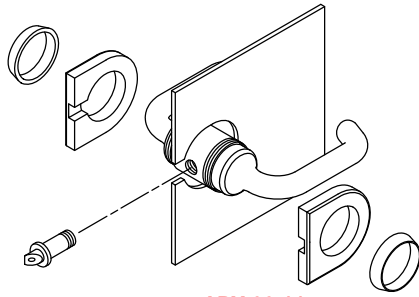
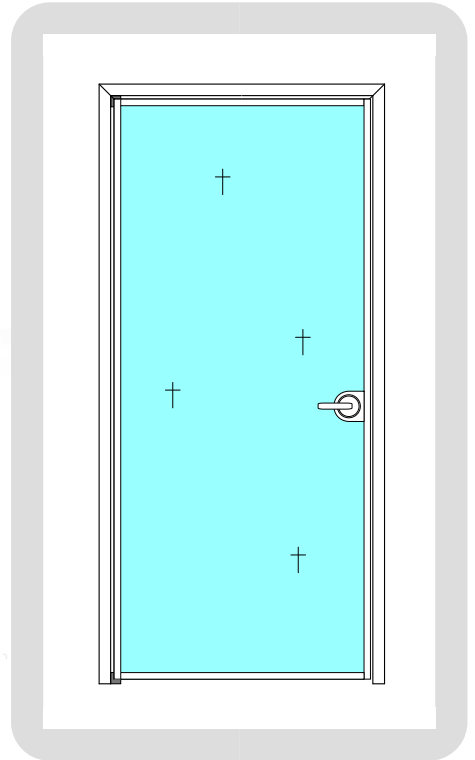

APX 03.11



APX 03.10

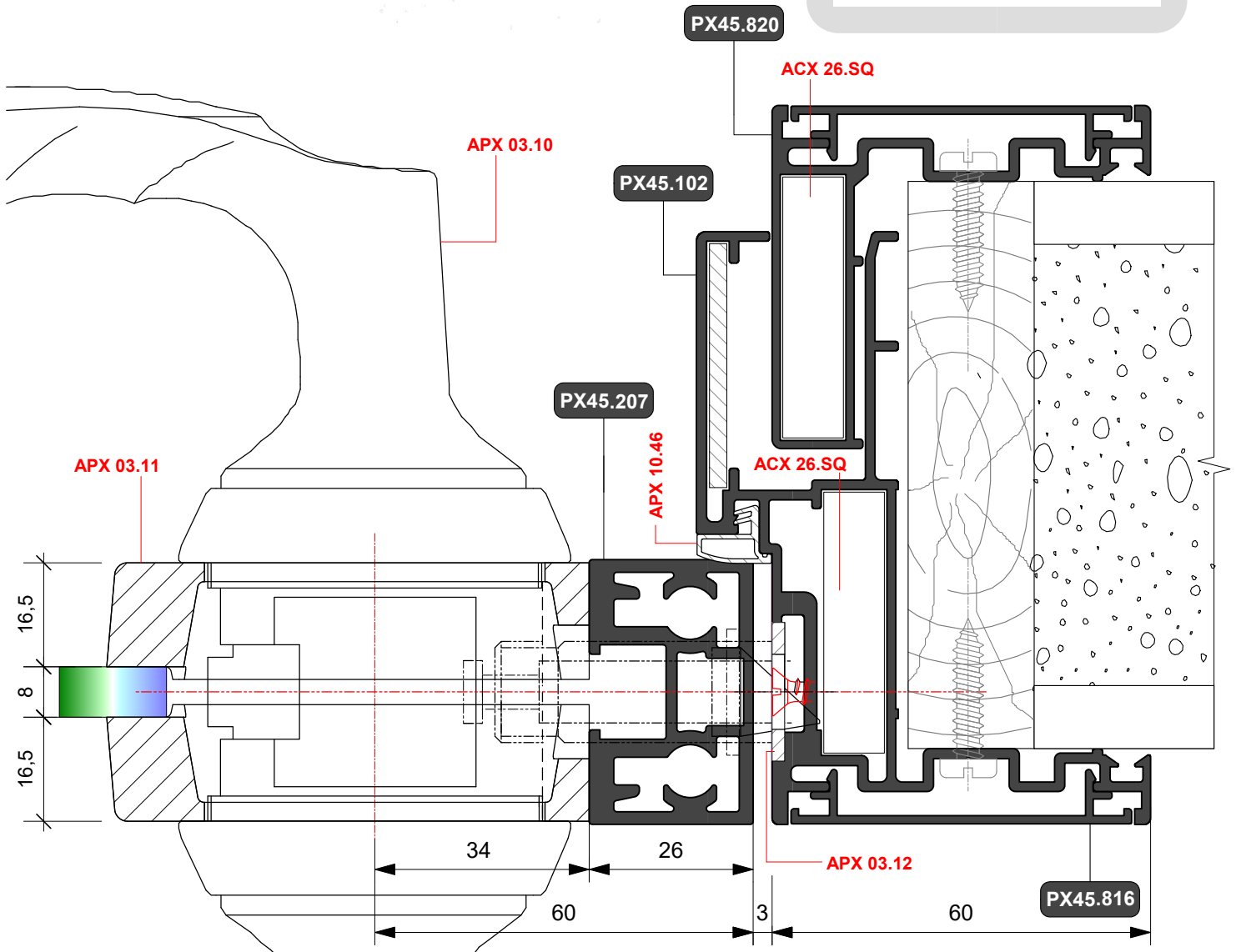



Linear

PORTA INTERNA
con anta in alluminio e legno

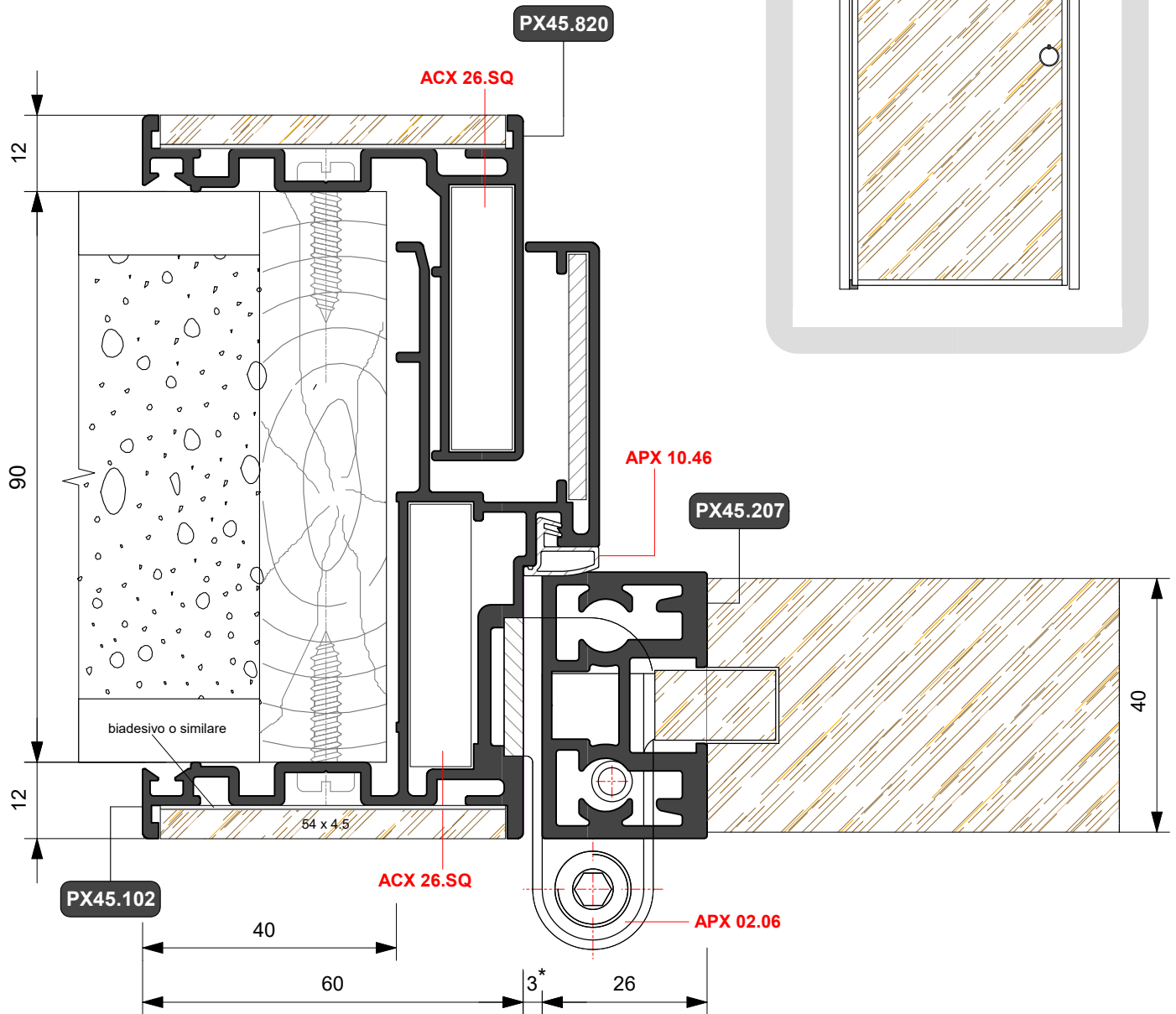
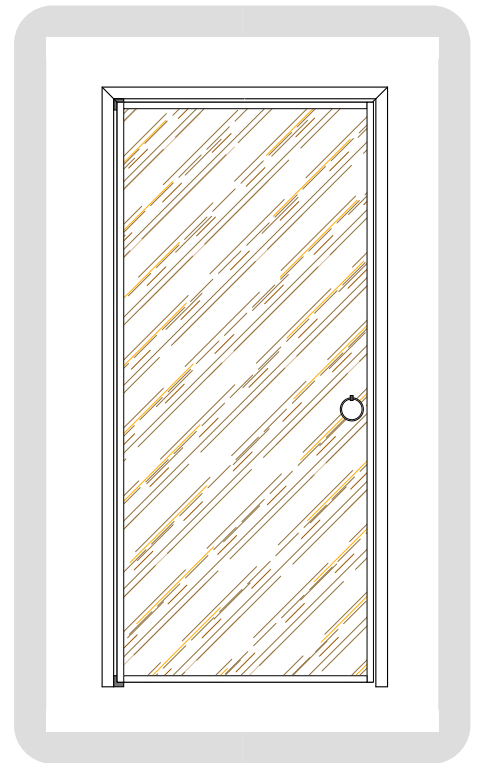

* Tolleranza +1 - 0 mm.



Linear

PORTA INTERNA
con anta in alluminio e vetro

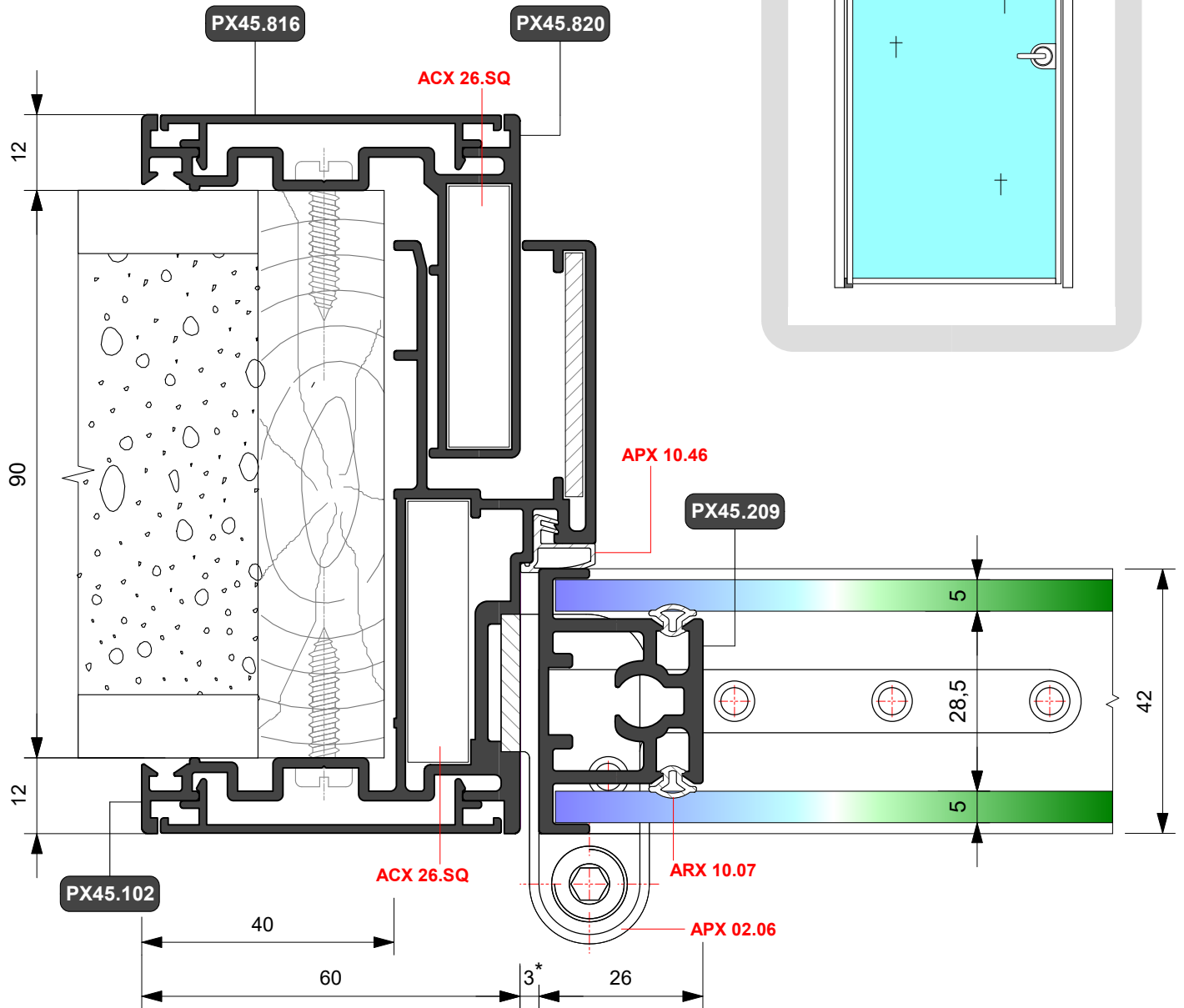
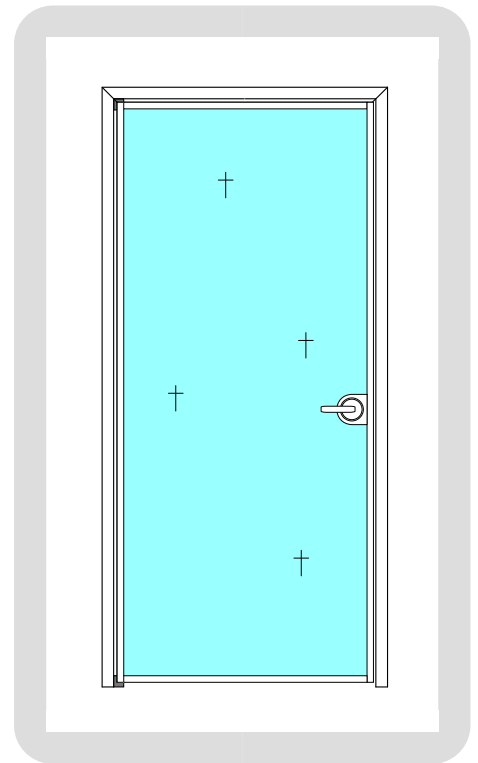

* Tolleranza +1 - 0 mm.



Linear

PORTA INTERNA
con anta in alluminio e vetro

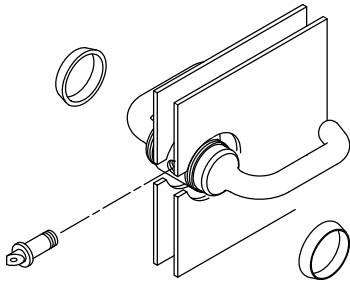

APX 03.10

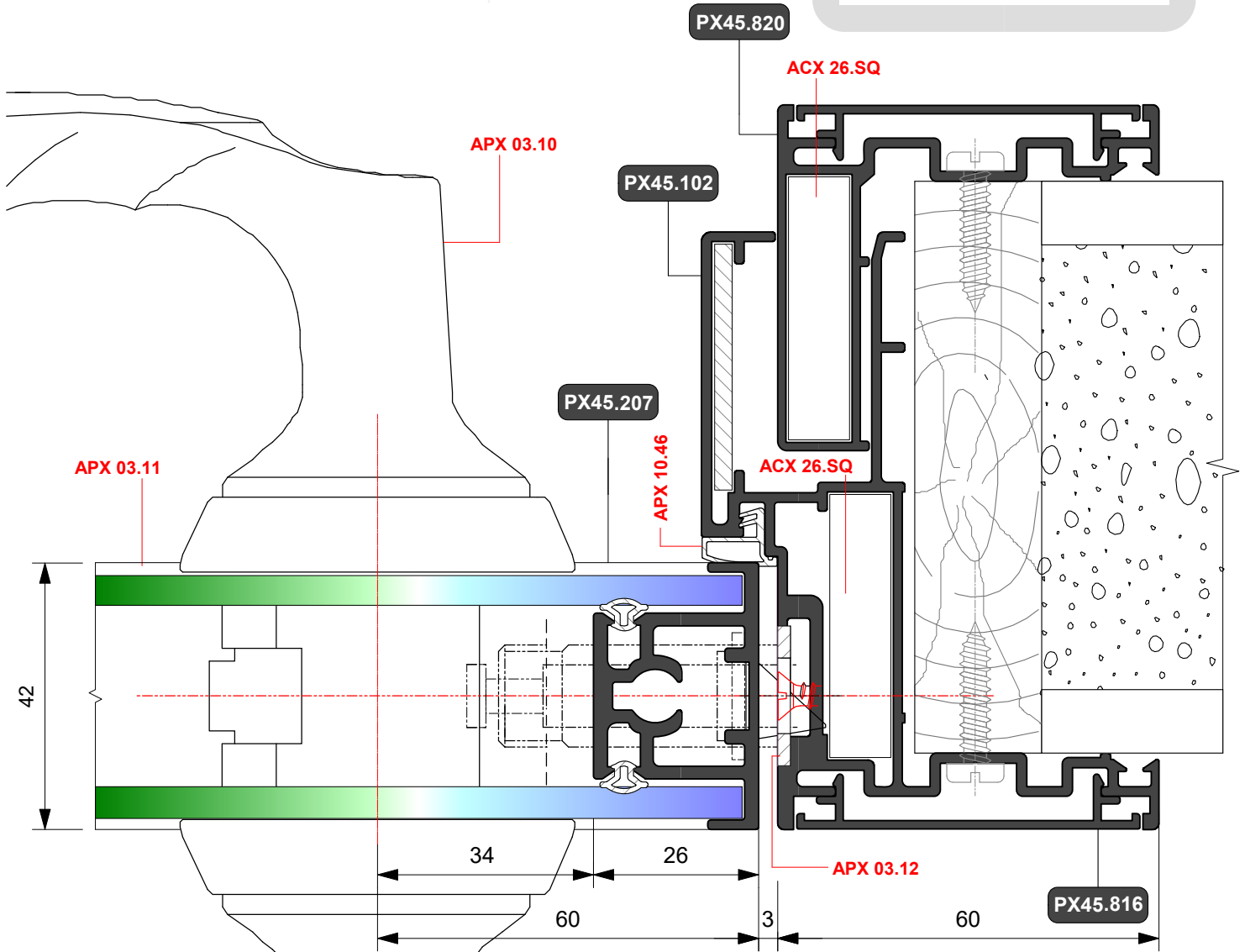
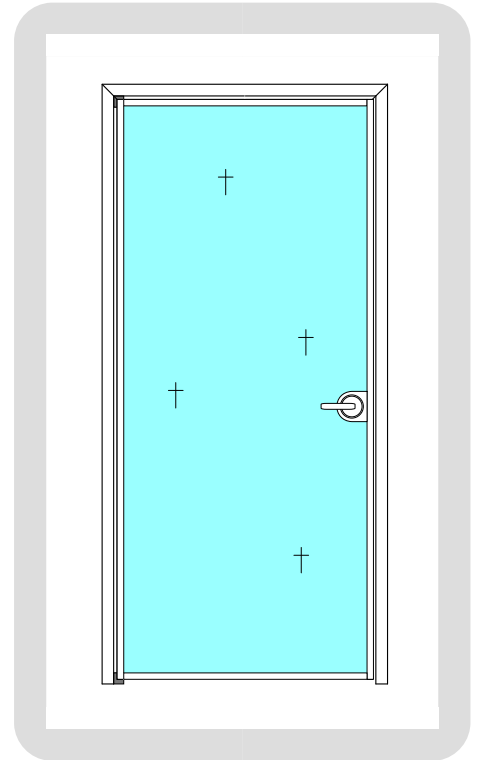



Linear

PORTA INTERNA
con anta in alluminio e legno

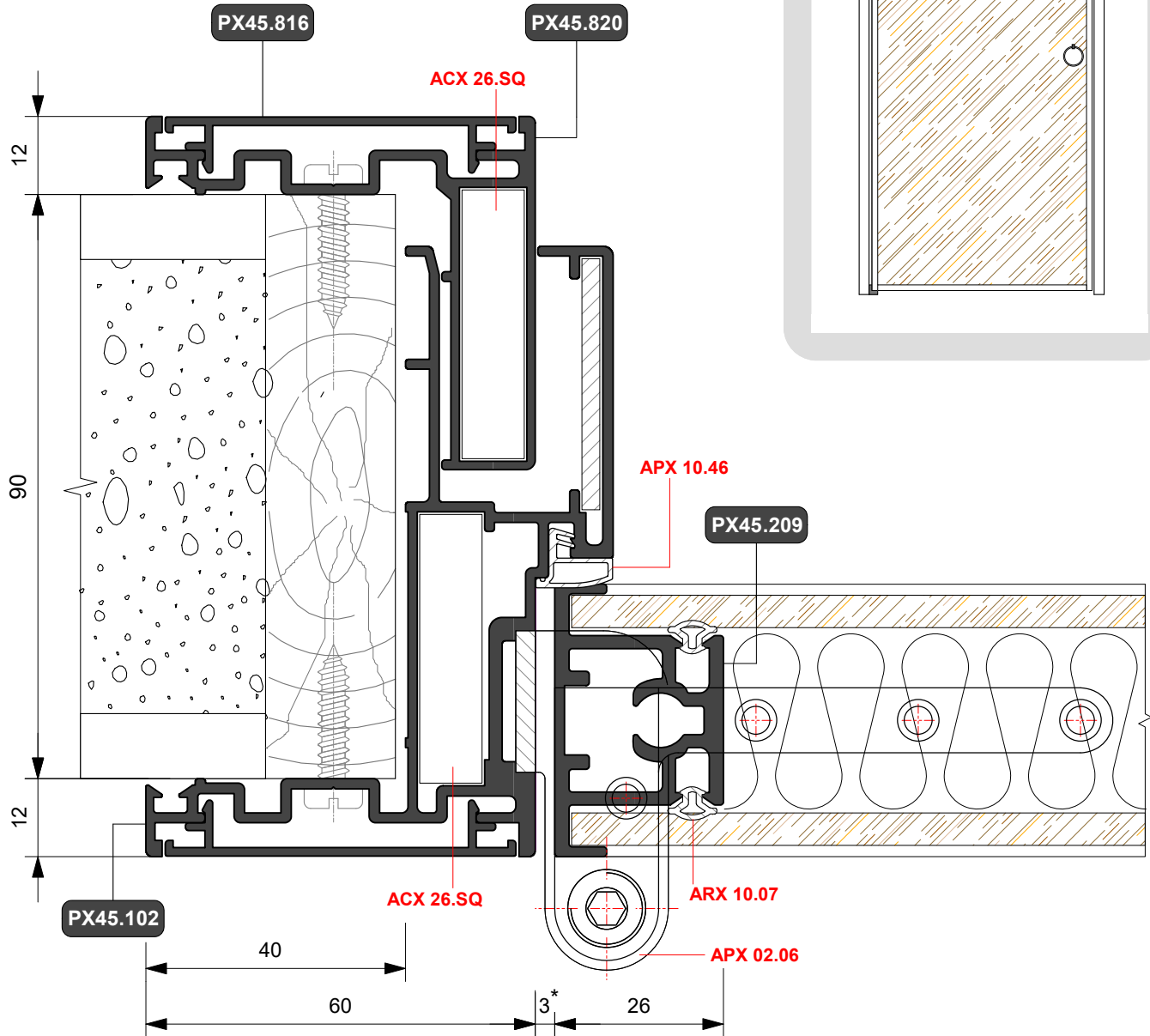
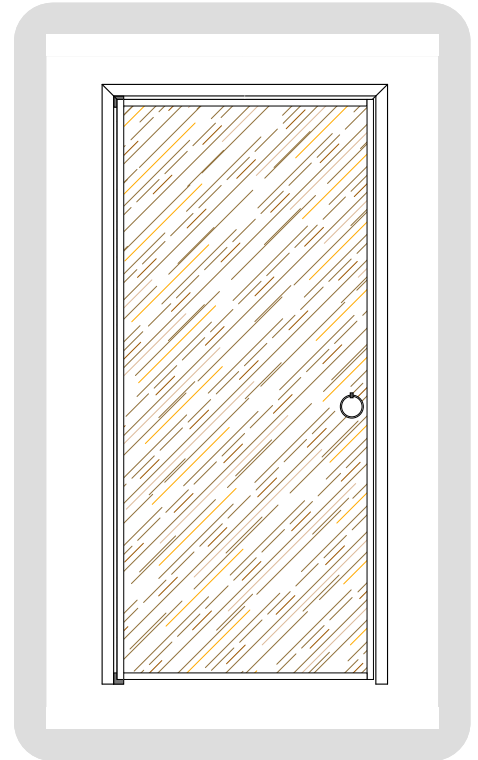

* Tolleranza +1 - 0 mm.



Linear

PORTA INTERNA
con anta in legno

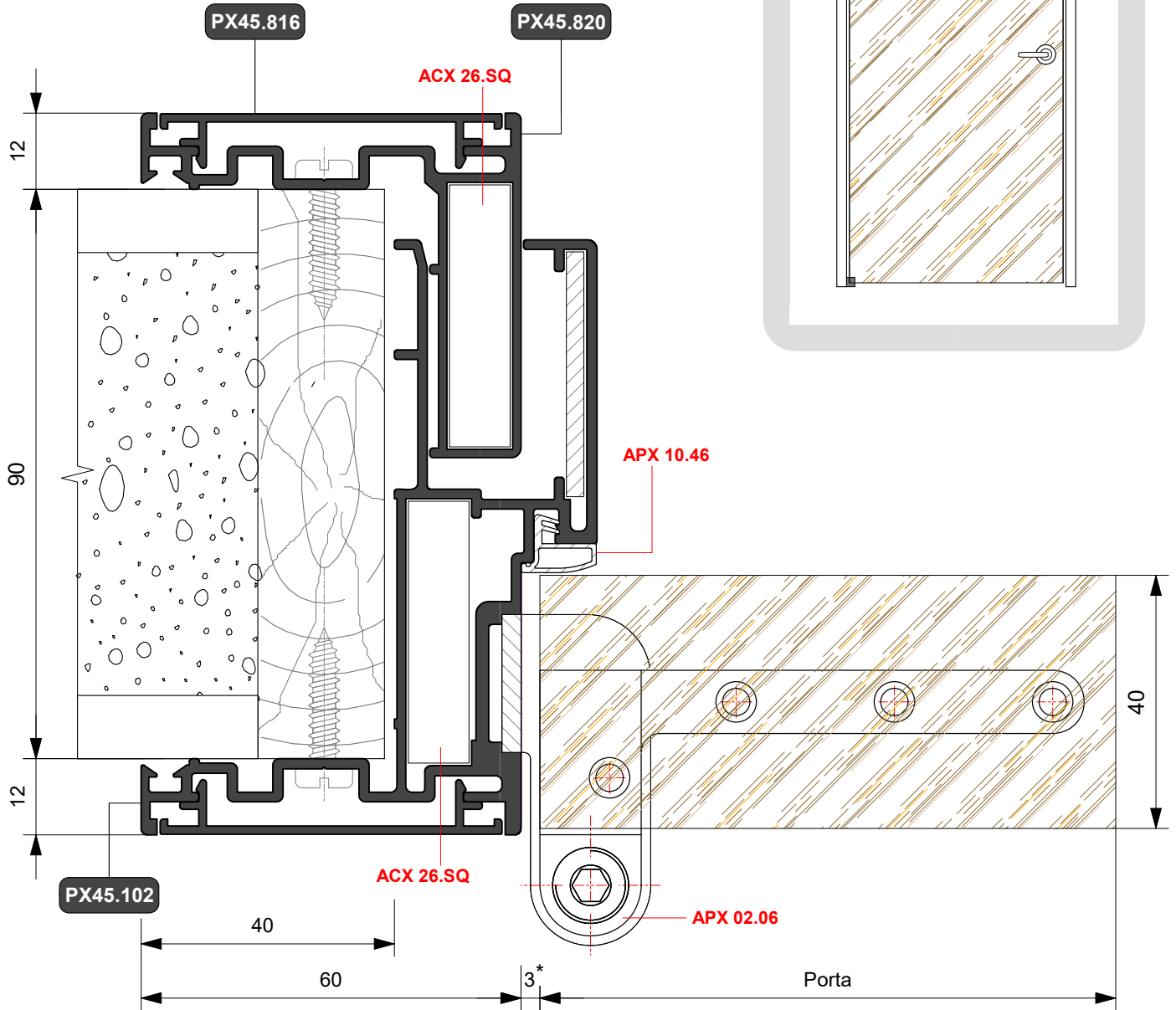
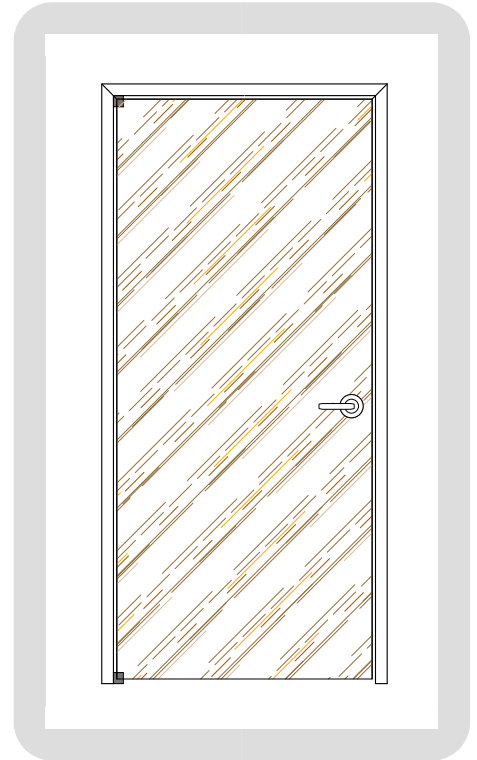

Variante con finitura in legno

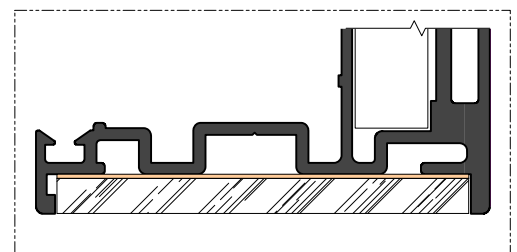

* Tolleranza +1 - 0 mm.



Linear

PORTA INTERNA
con anta in legno

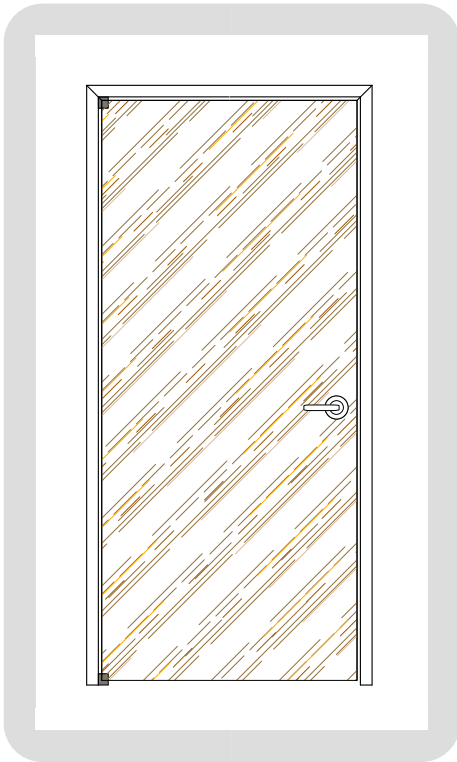

APX 03.15



APX 03.16

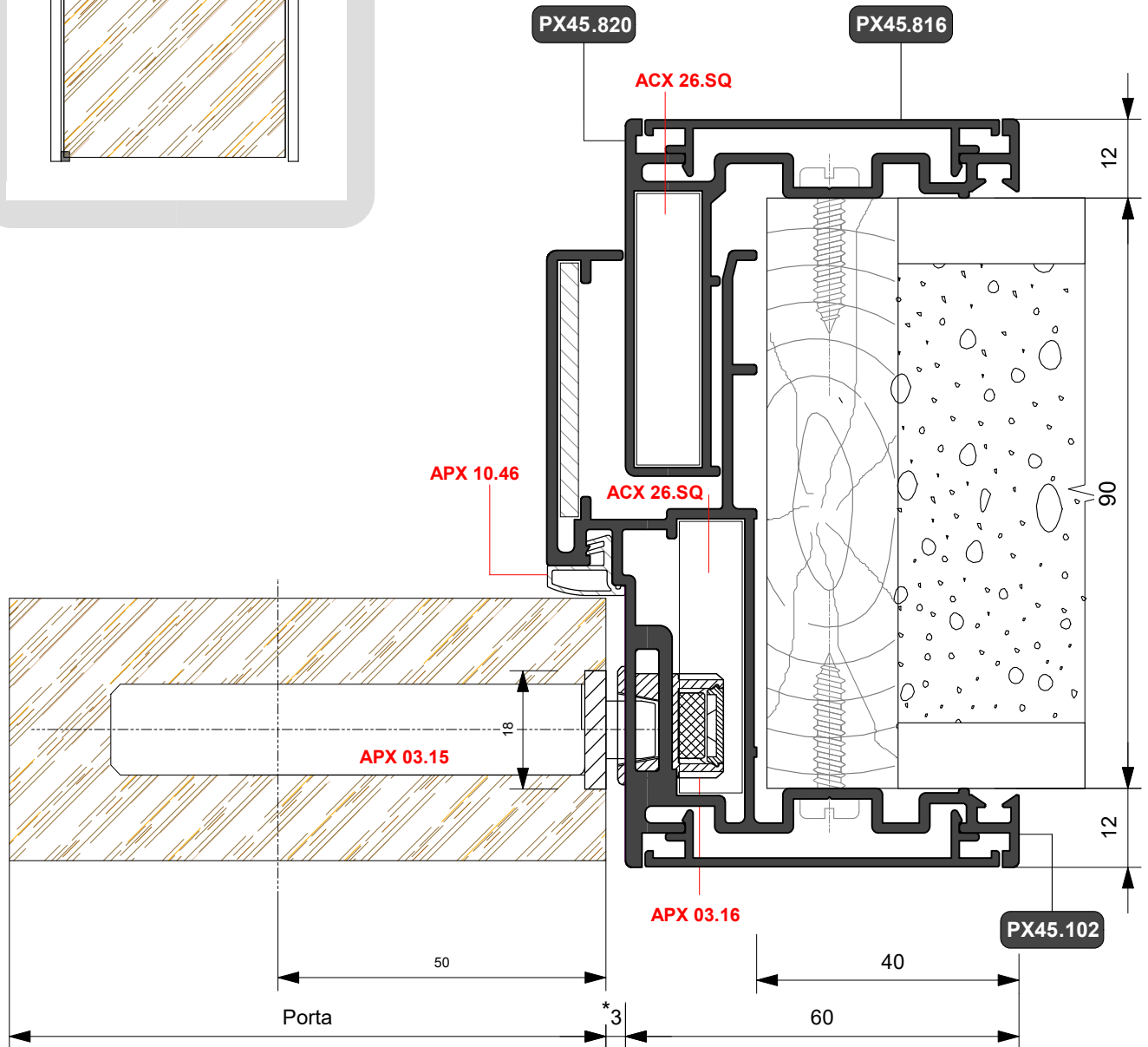

* Tolleranza +1 - 0 mm.



Linear

PORTA INTERNA
con anta in alluminio e vetro

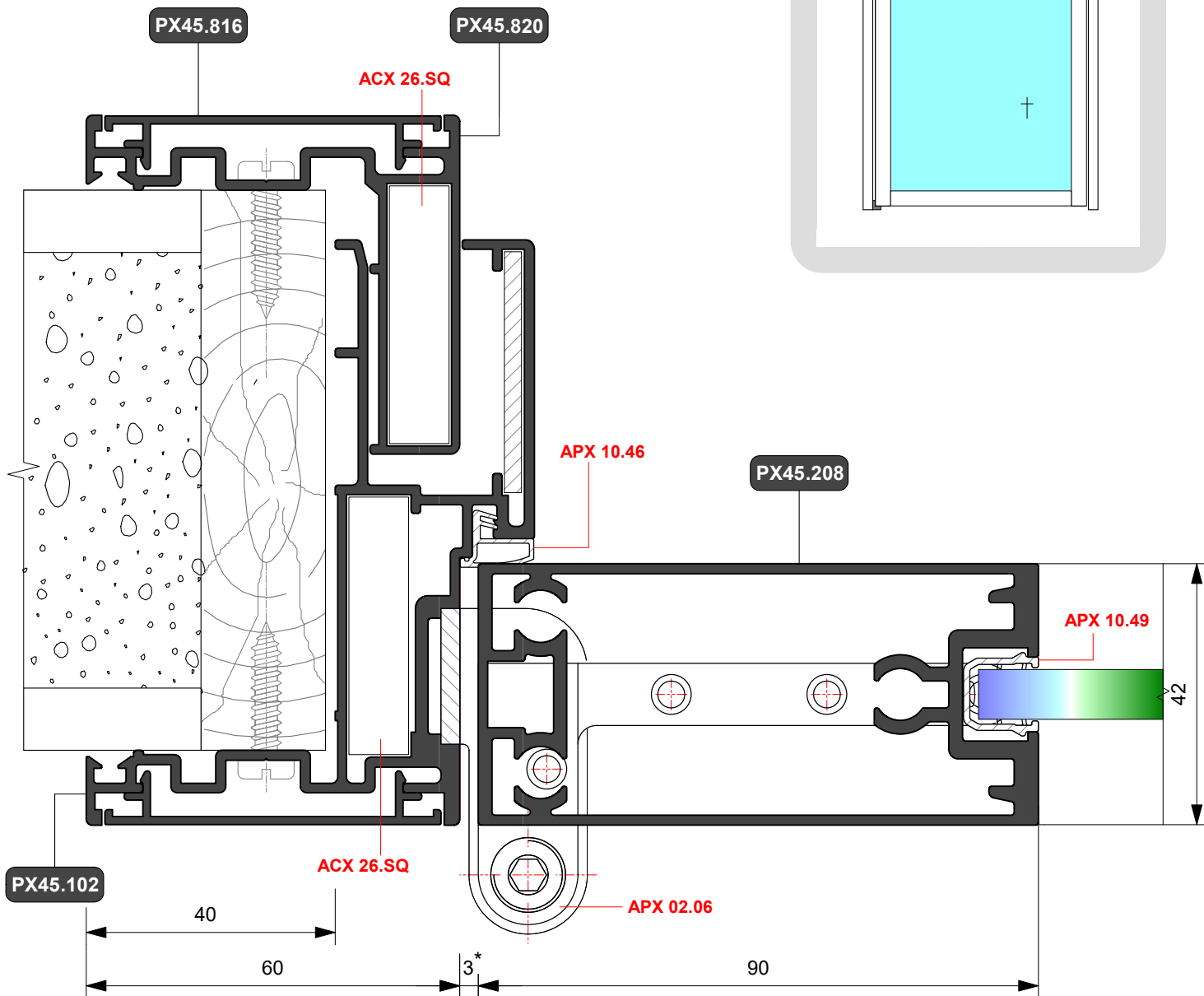
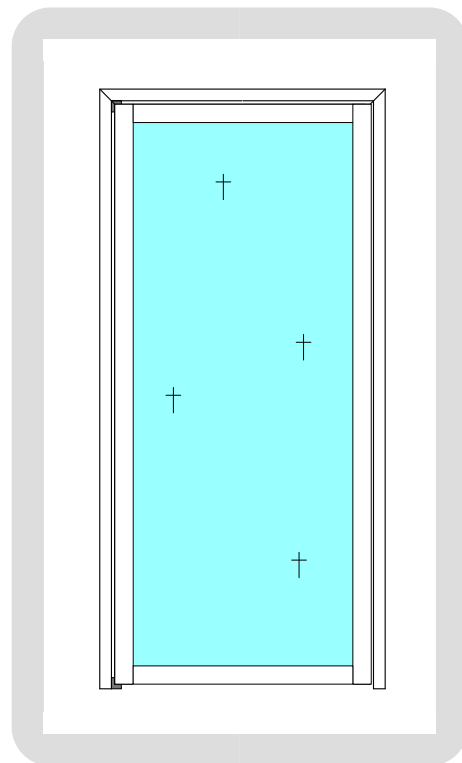



Linear

PORTA INTERNA
con anta in alluminio e vetro

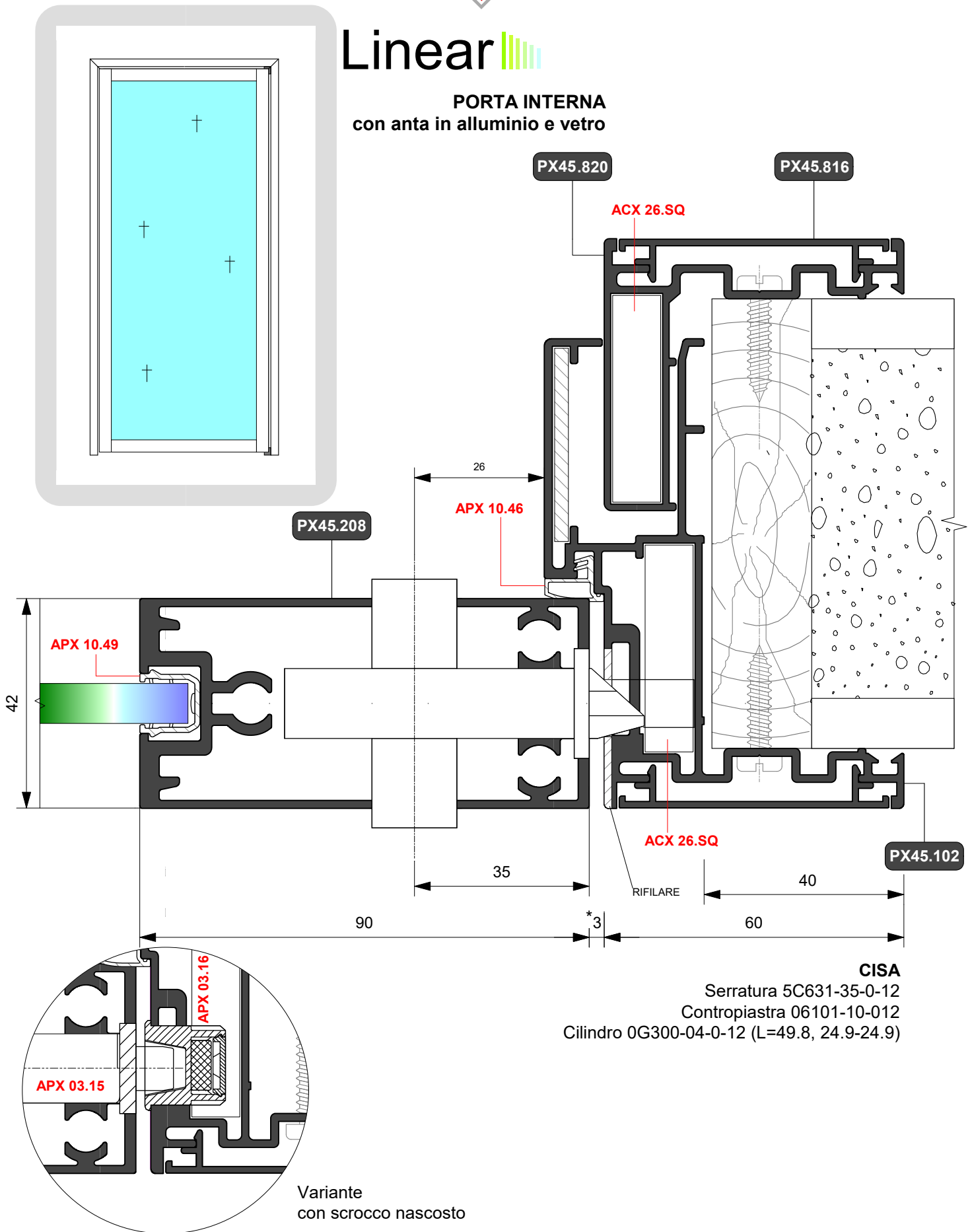

CISA
Serratura 5C631-35-0-12
Contropiastra 06101-10-012
Cilindro 0G300-04-0-12 (L=49.8, 24.9-24.9)

Variante
con scrocco nascosto



Linear

PORTA INTERNA
con in vetro



APX 02.07

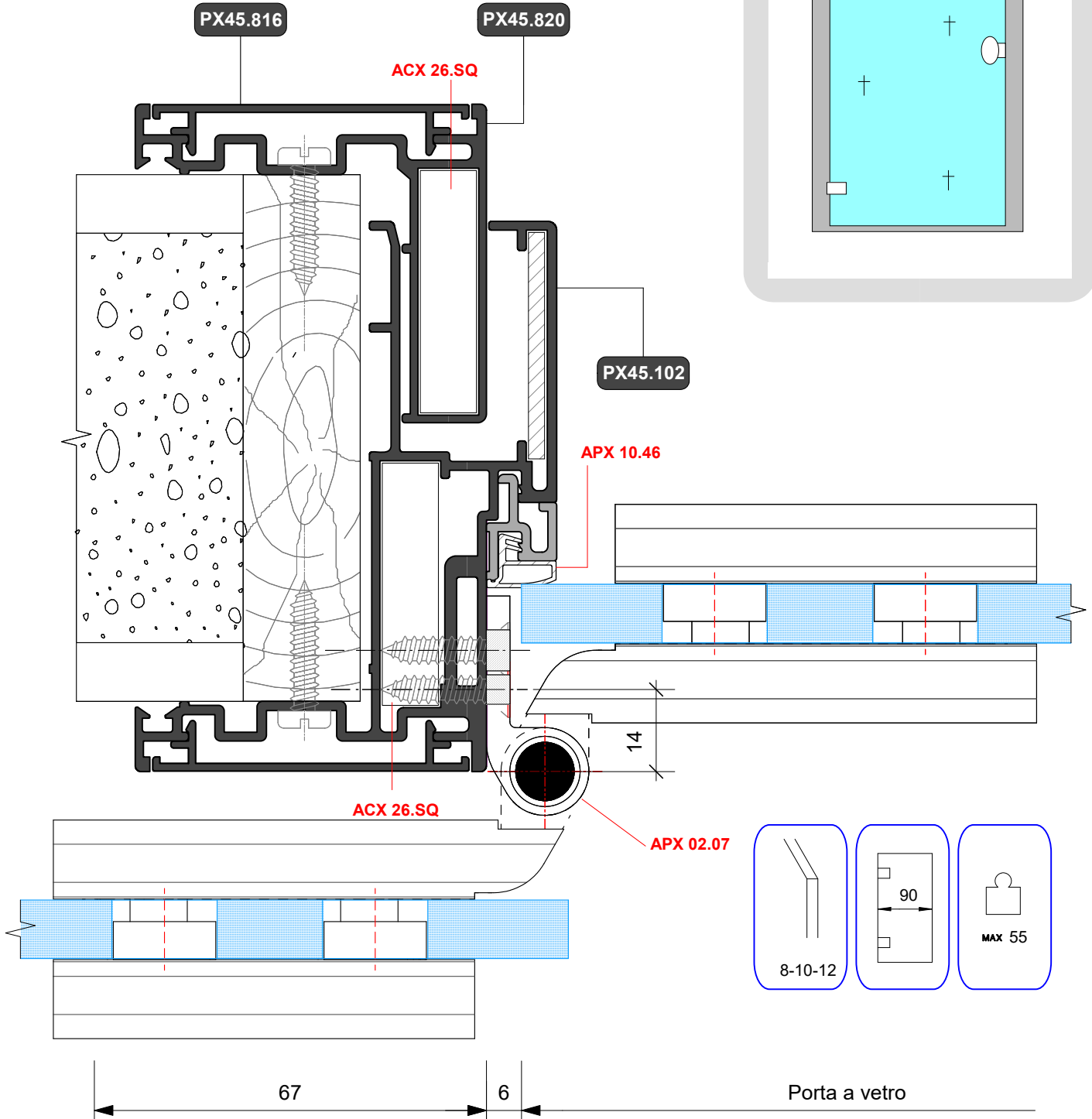
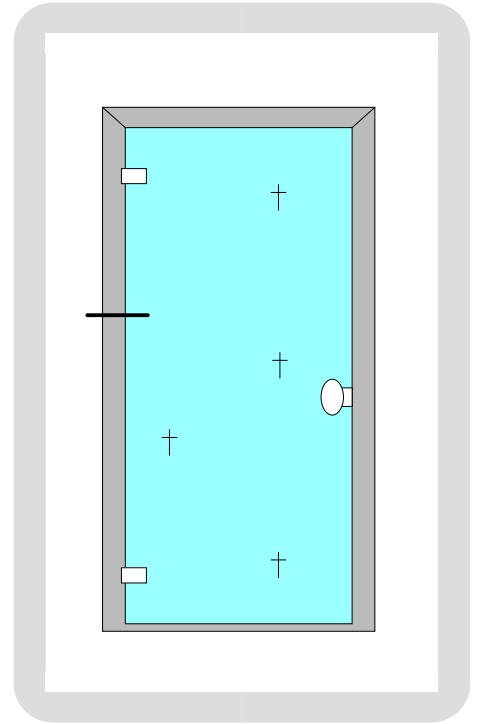

Porta a vetro

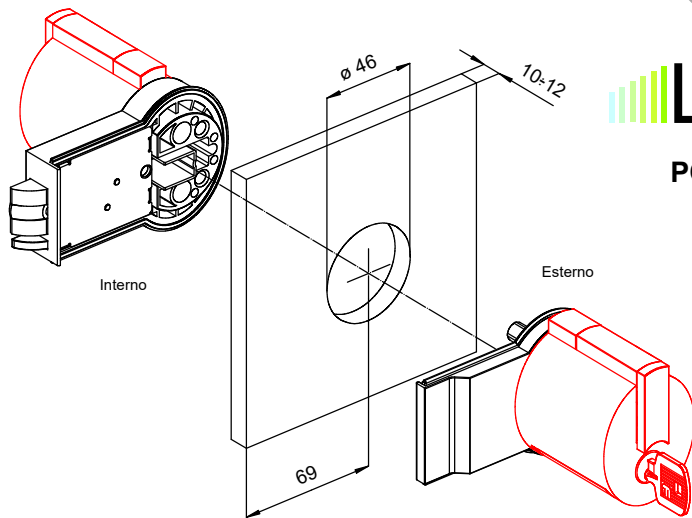

Linear

PORTA INTERNA
con in vetro

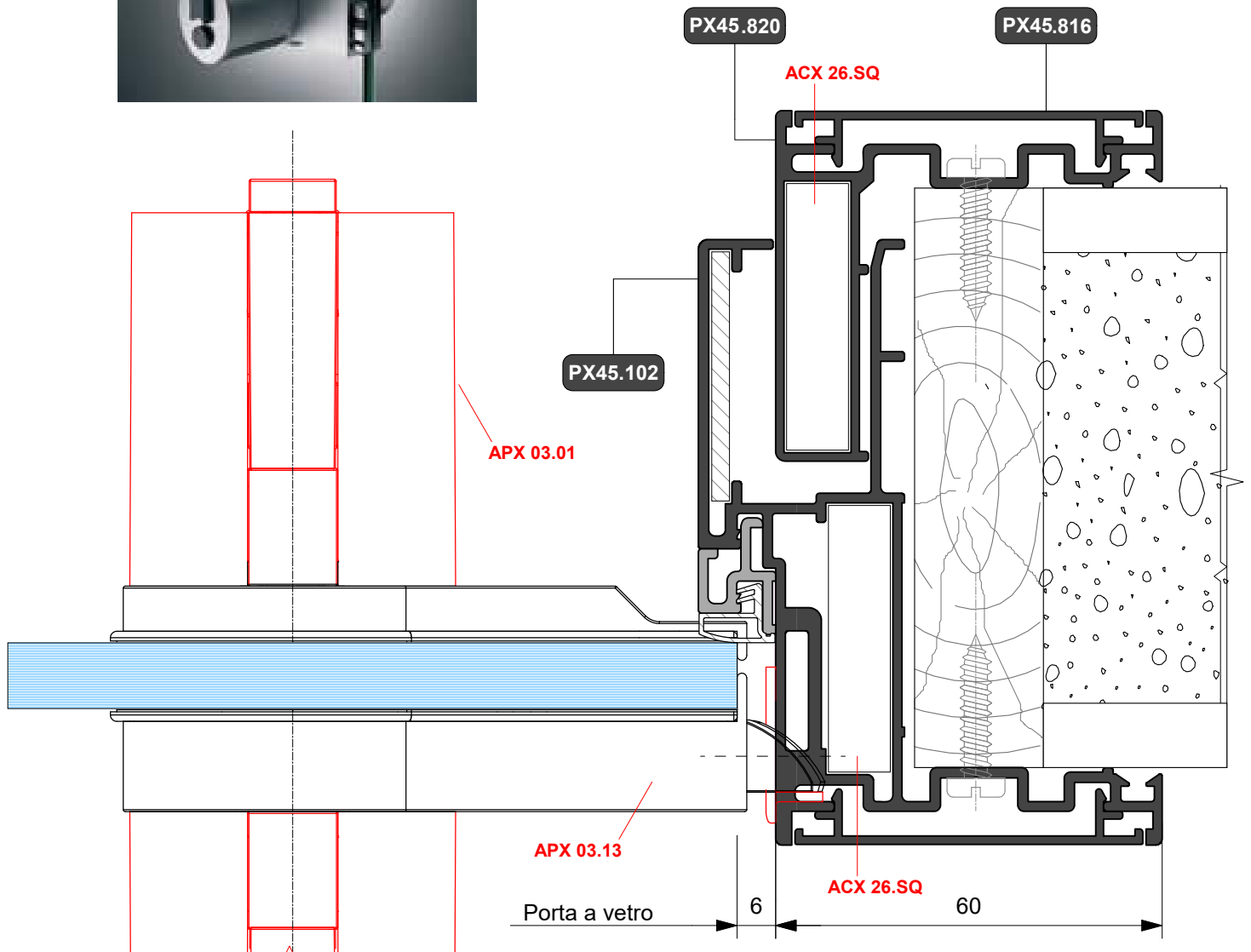
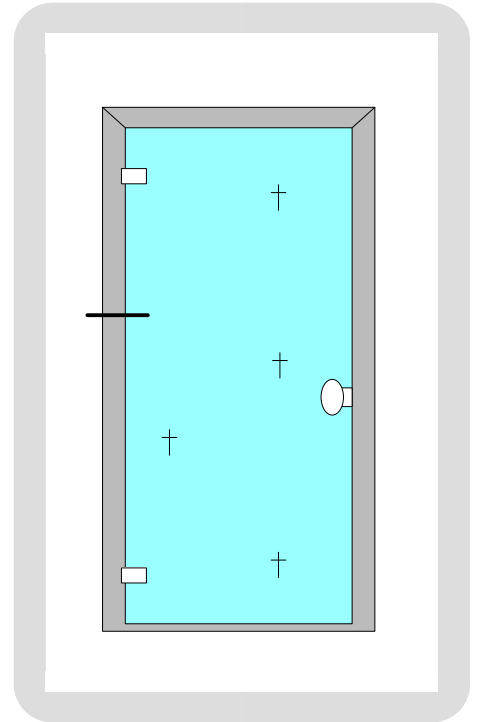

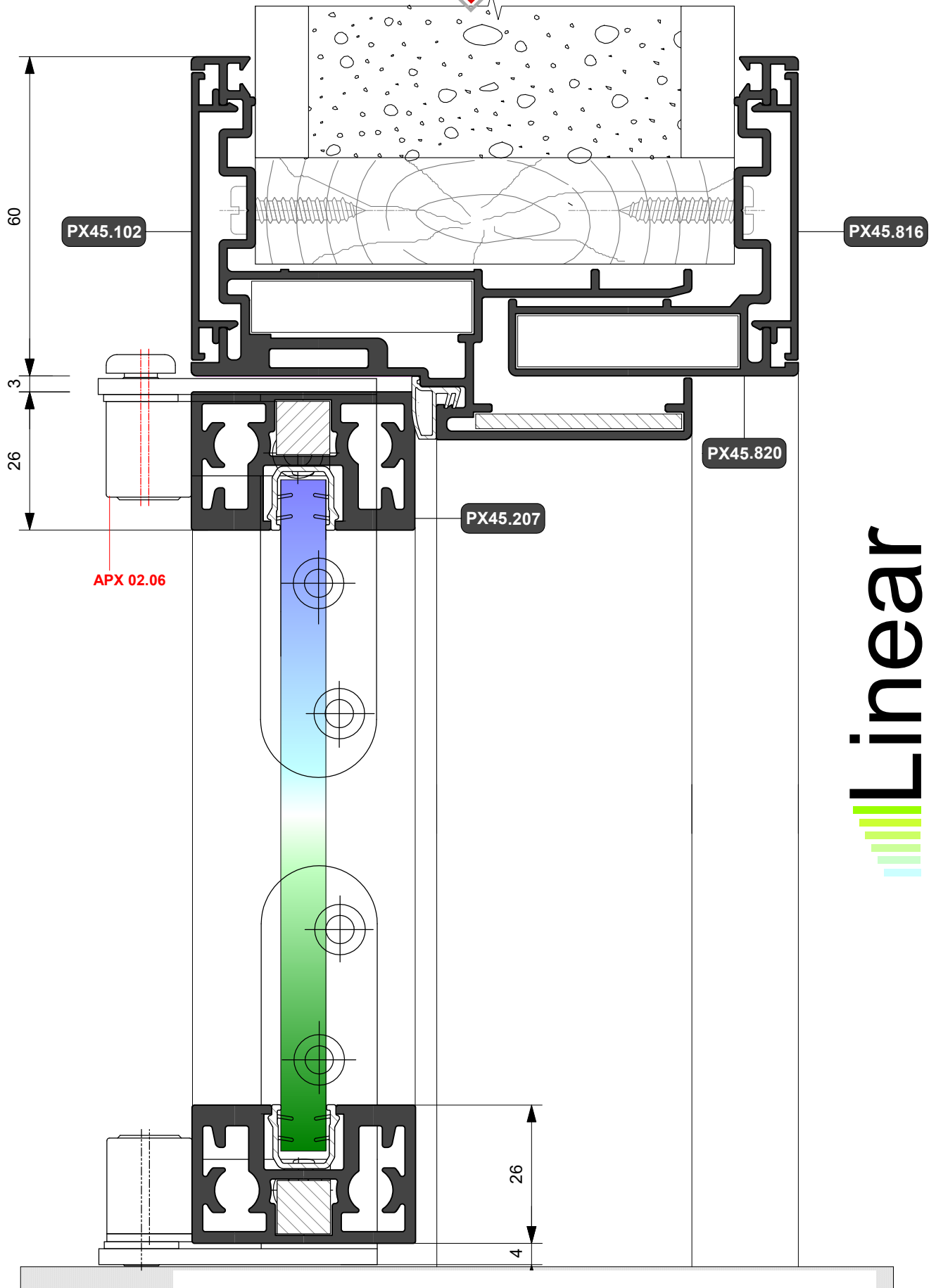

Linear



Linear

PORTA INTERNA
a 2 ante con soprauce

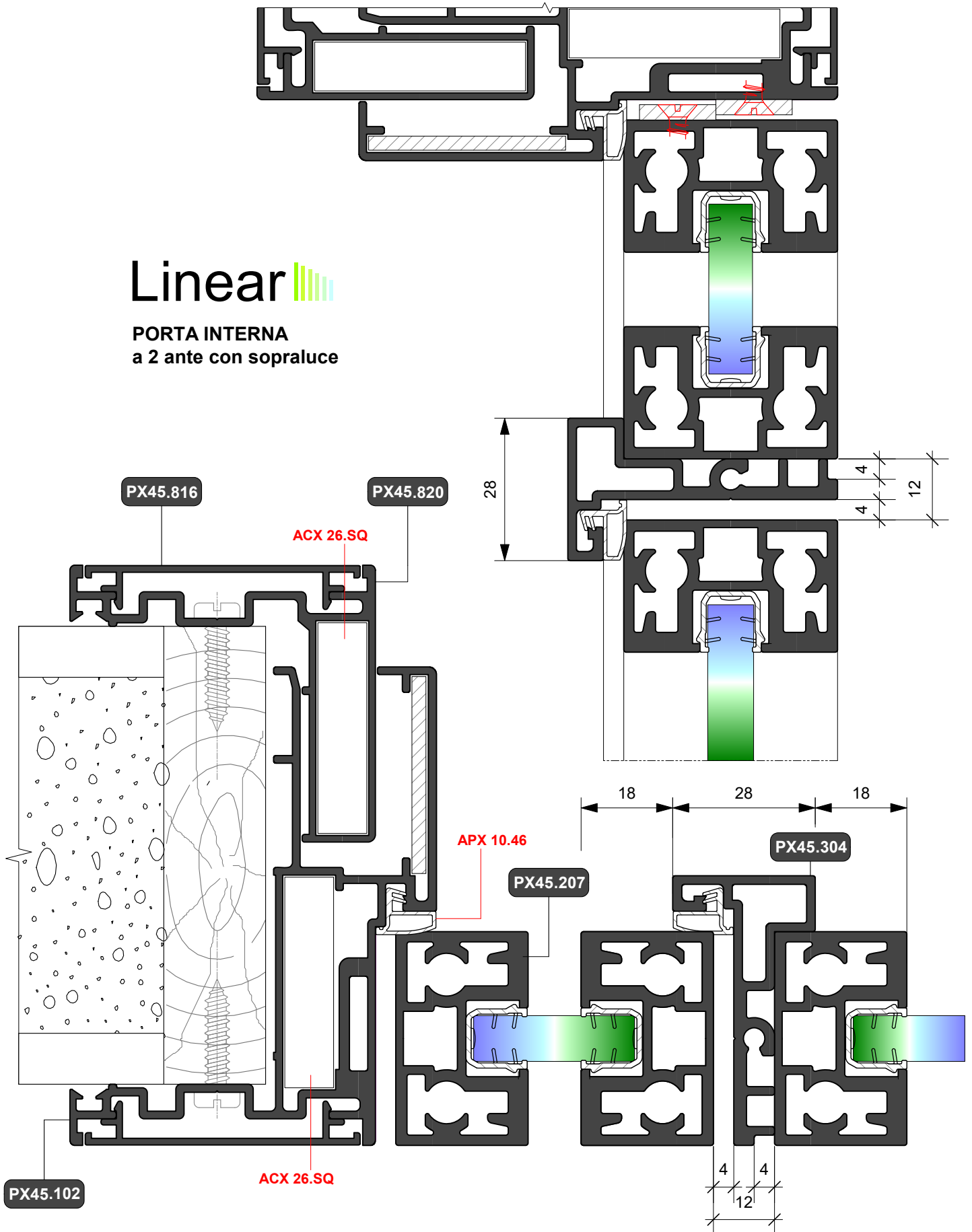



Linear

PORTA INTERNA
a 2 ante con soprauce

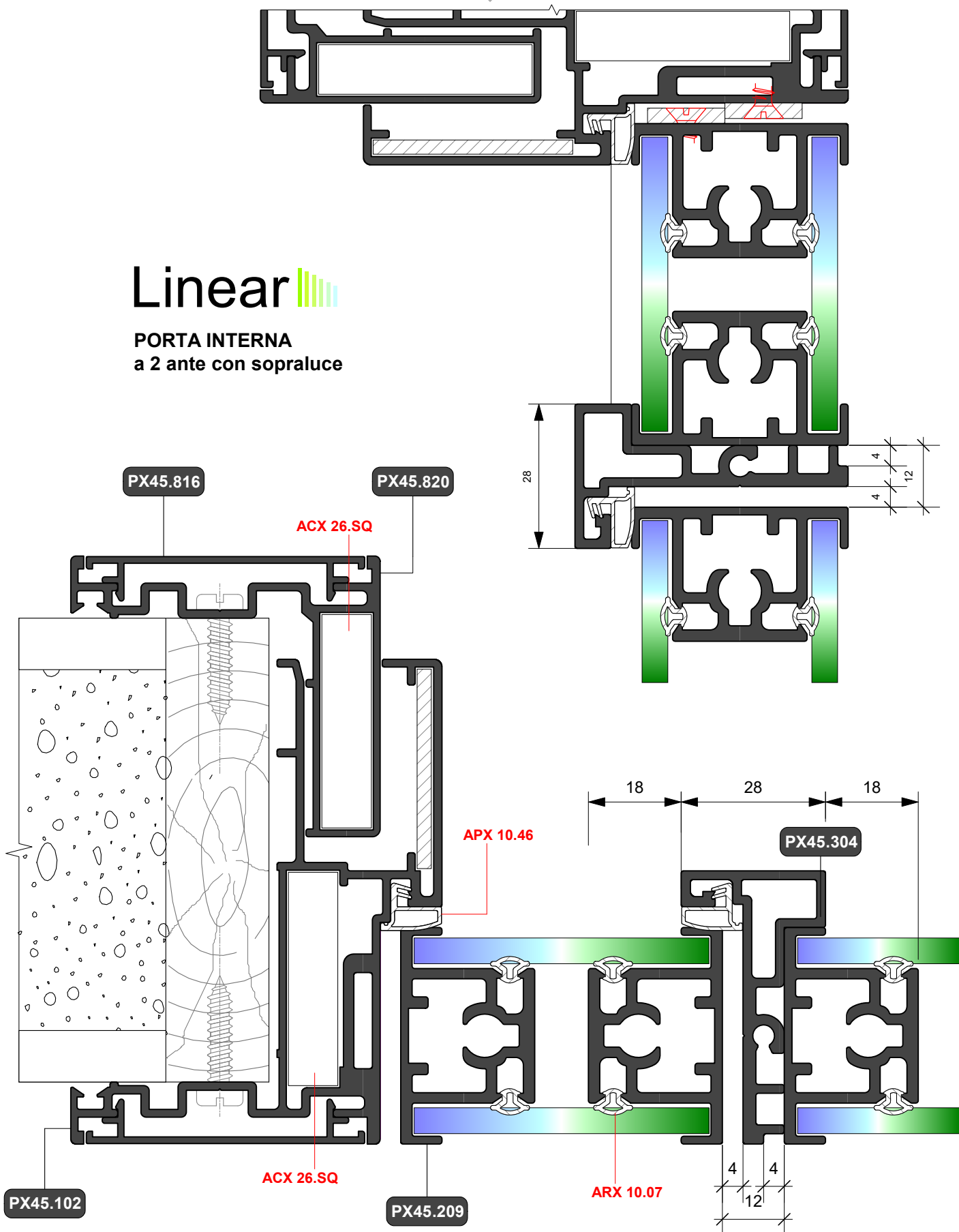



**Porta a scomparsa scorrevole con controtelaio
"Scrigno Base 105" per intonaco**

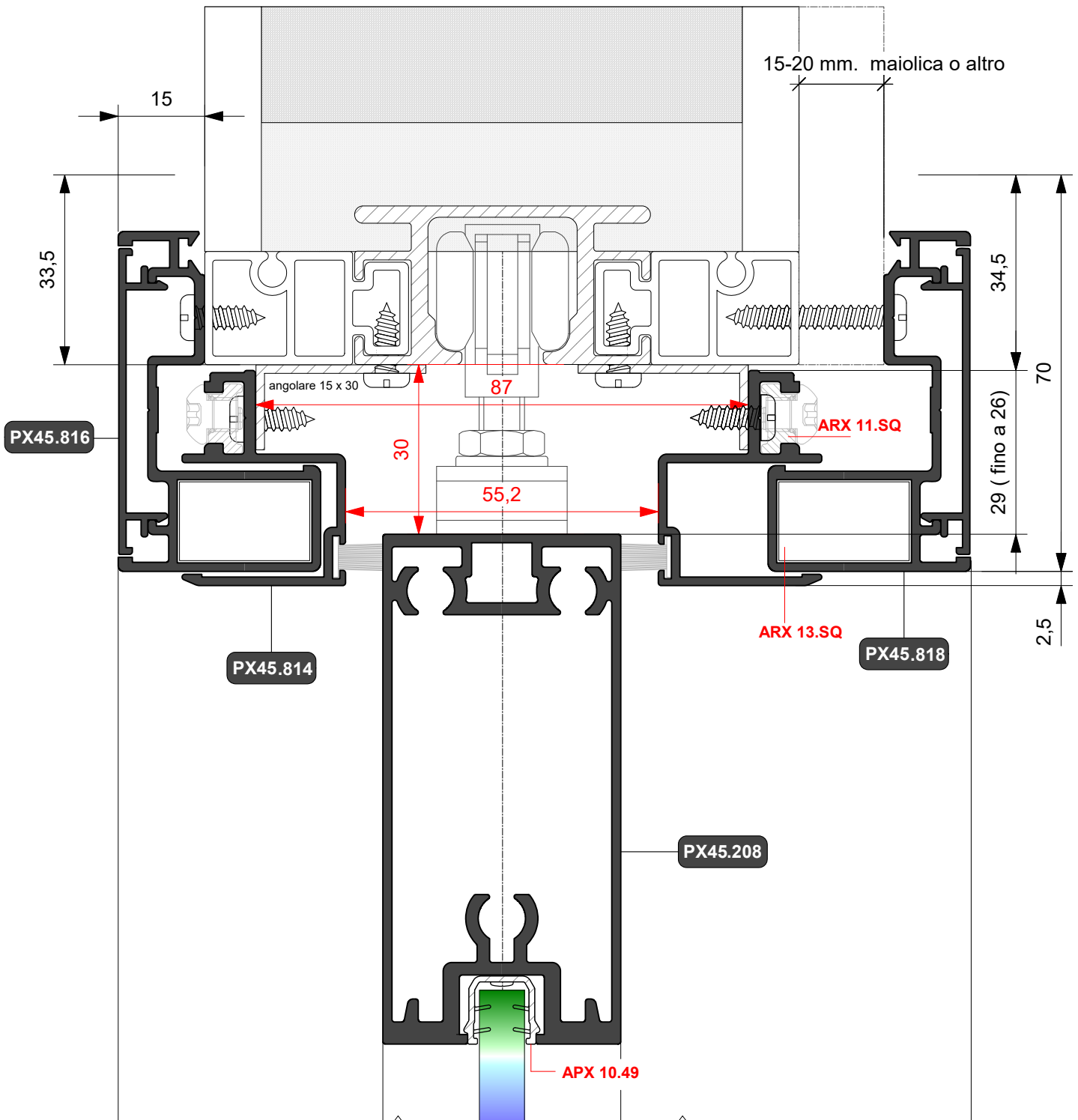
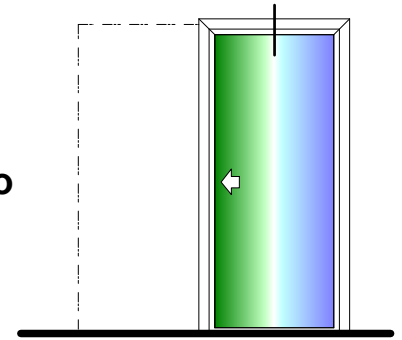



**Porta a scomparsa scorrevole con controltaio
"Scigno Base 105" per intonaco**

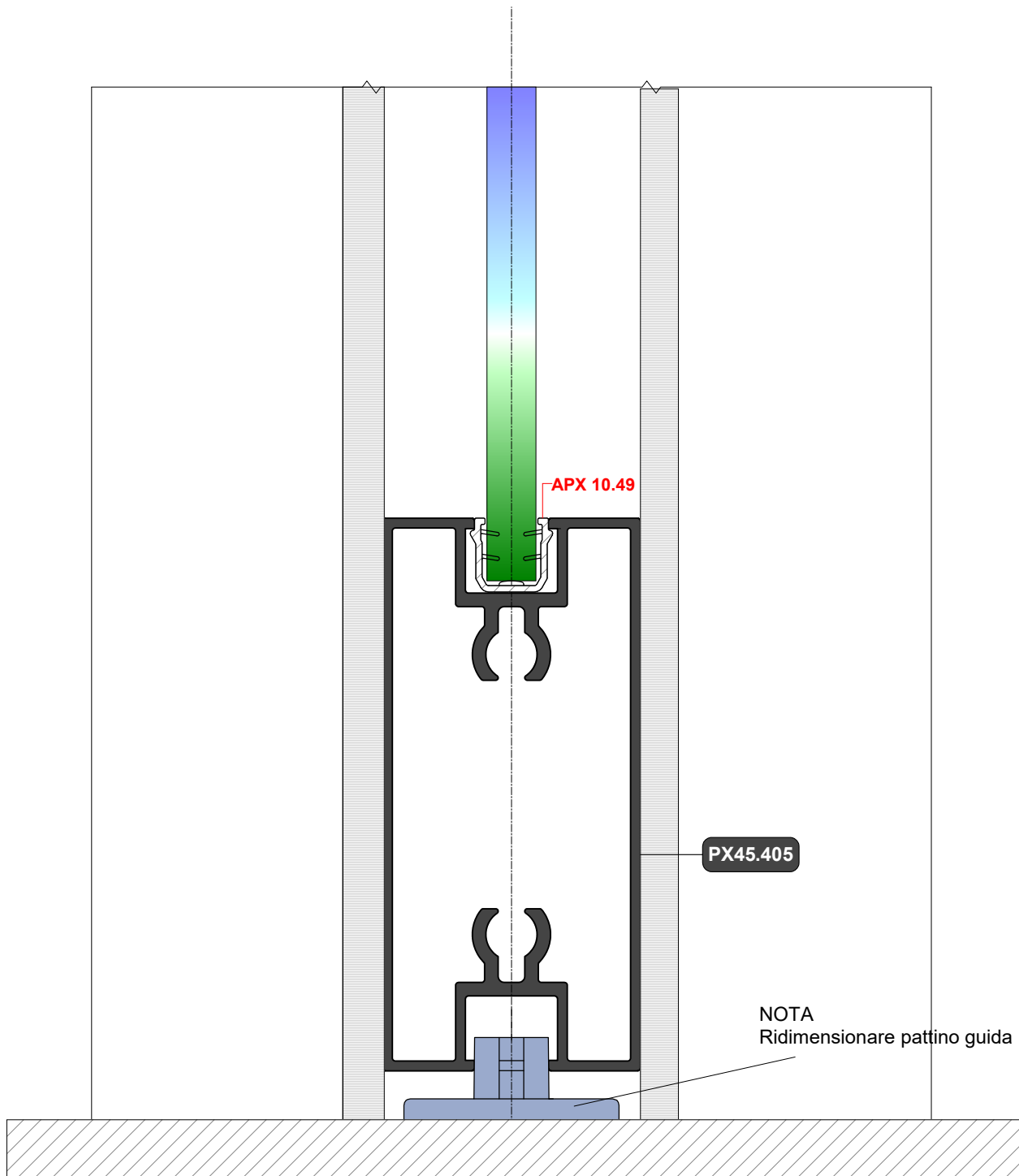
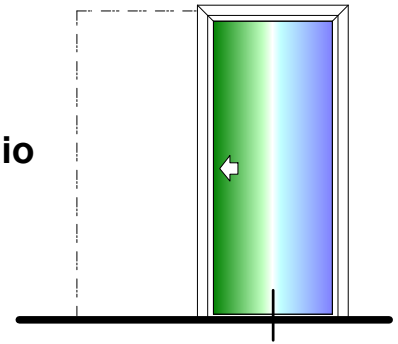



Porta a scomparsa scorrevole con control telaio "Scrinno Base 105" per intonaco

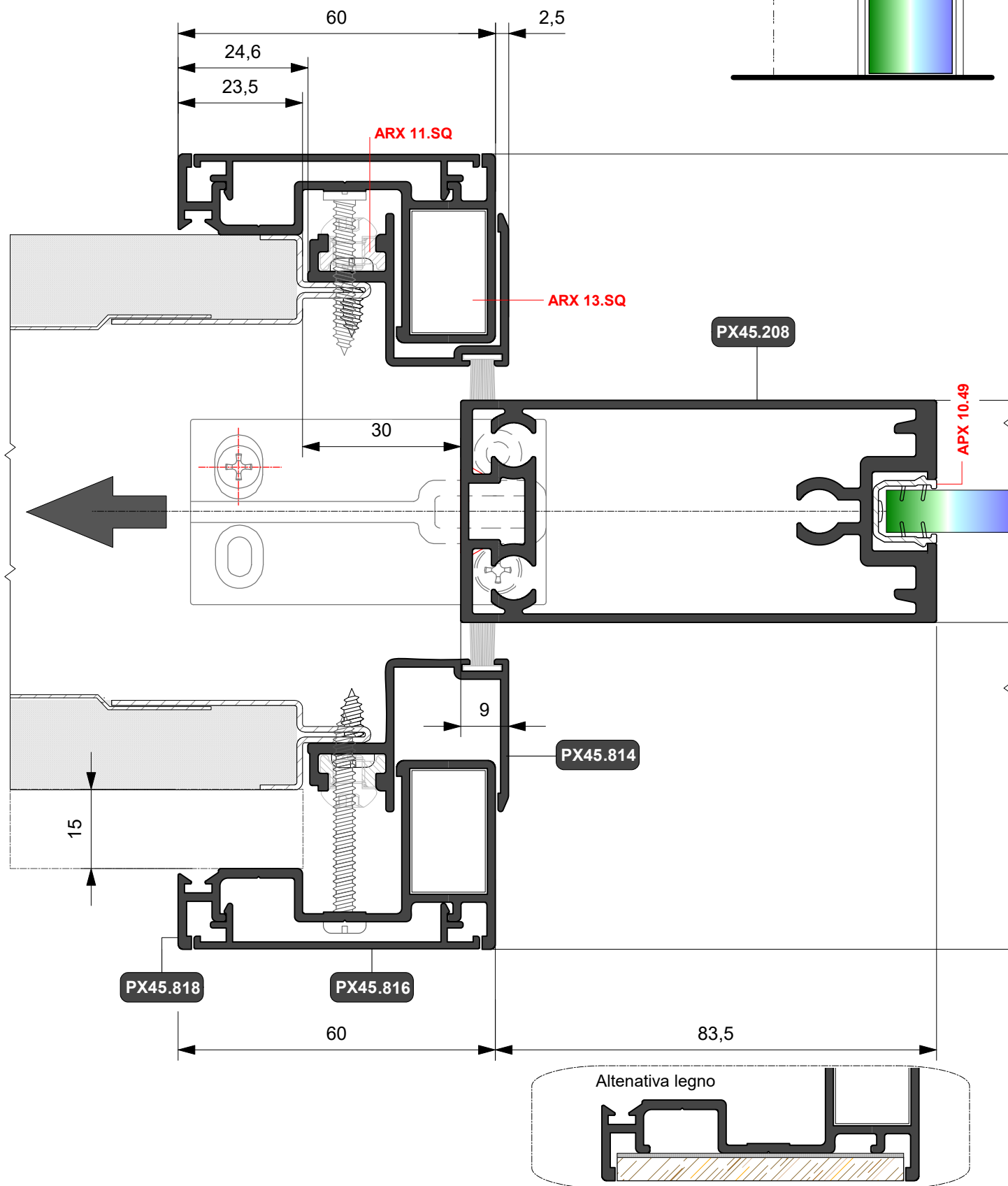
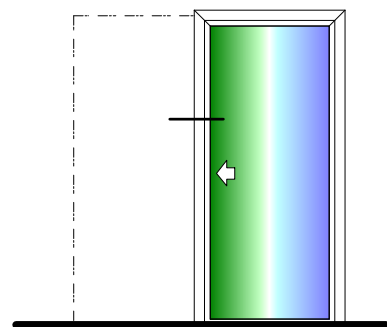



**Porta a scomparsa scorrevole con controteatro
"Scrigno Base 105" per intonaco**

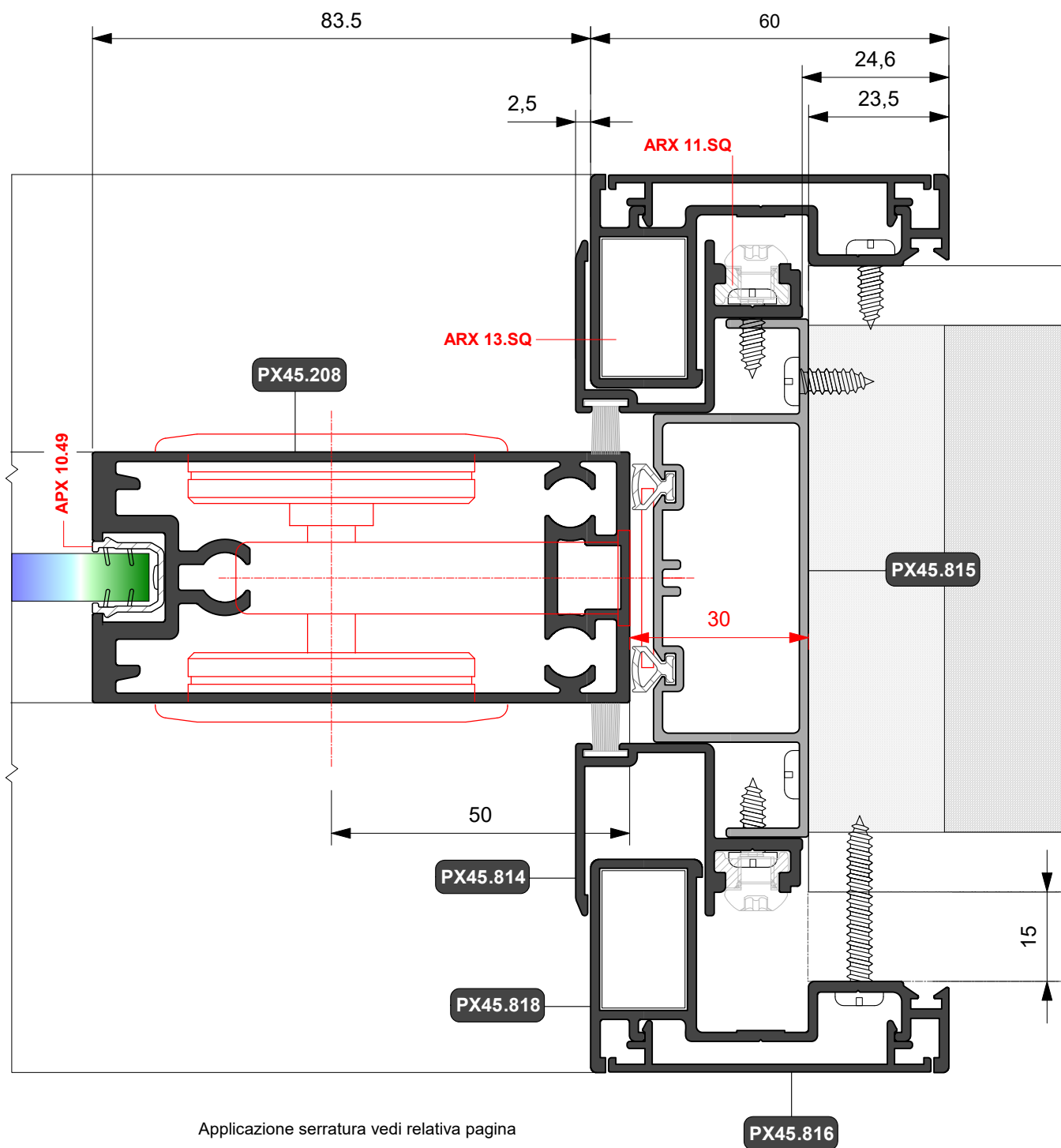
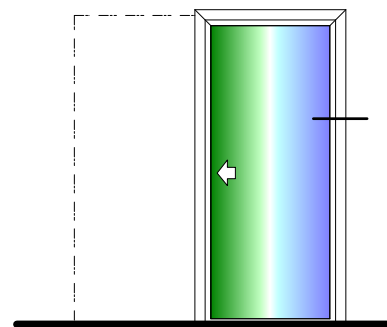



**Porta a scomparsa scorrevole con controtelaio
"Scrinio Base 105" per intonaco**

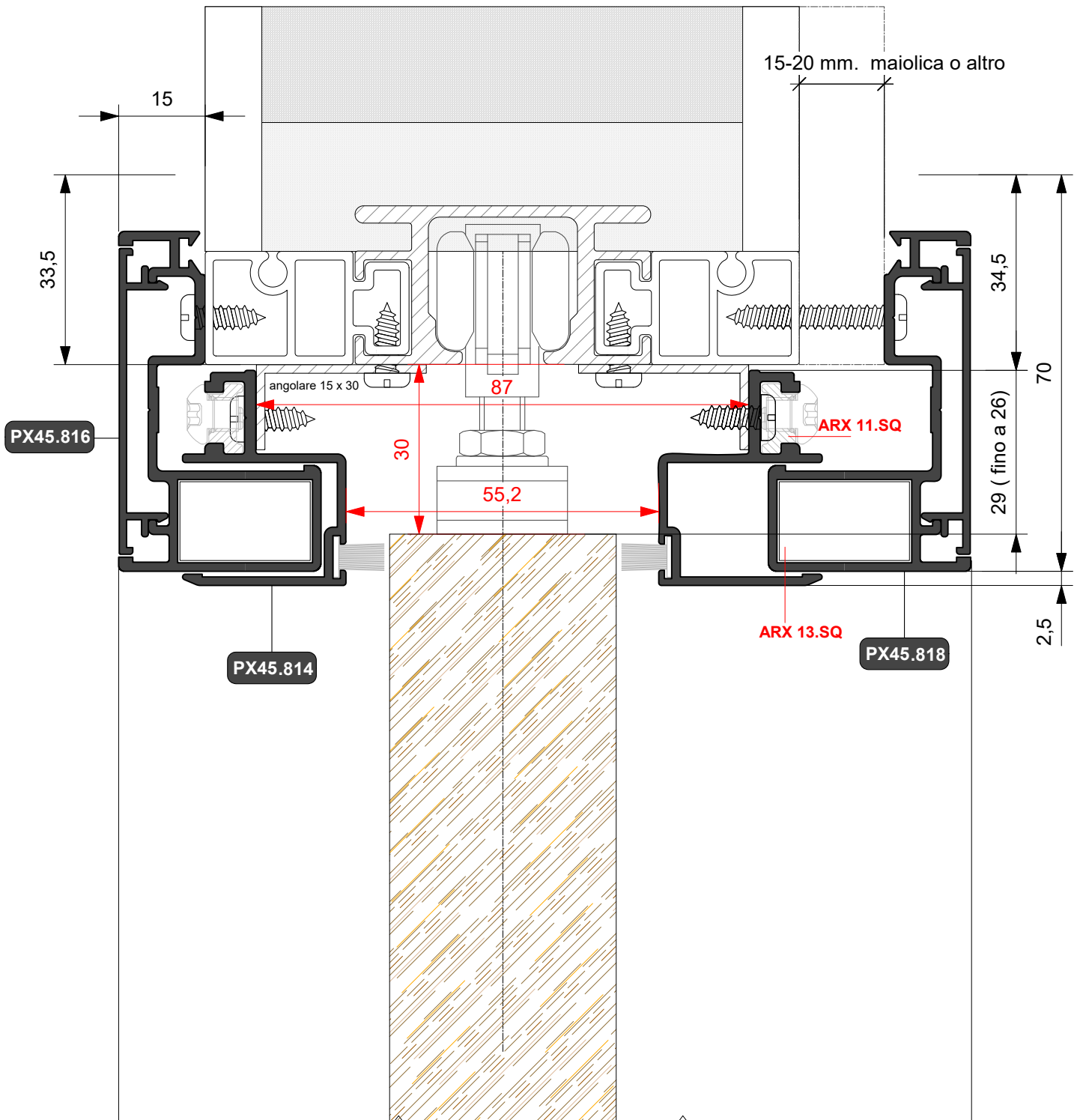
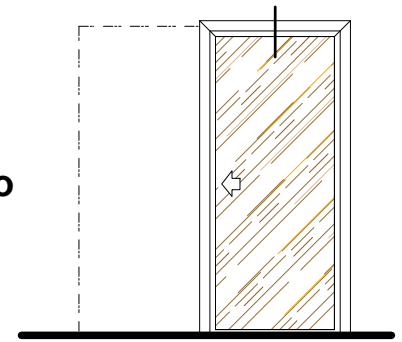



**Porta a scomparsa scorrevole con controltaio
"Scrinio Base 105" per intonaco**

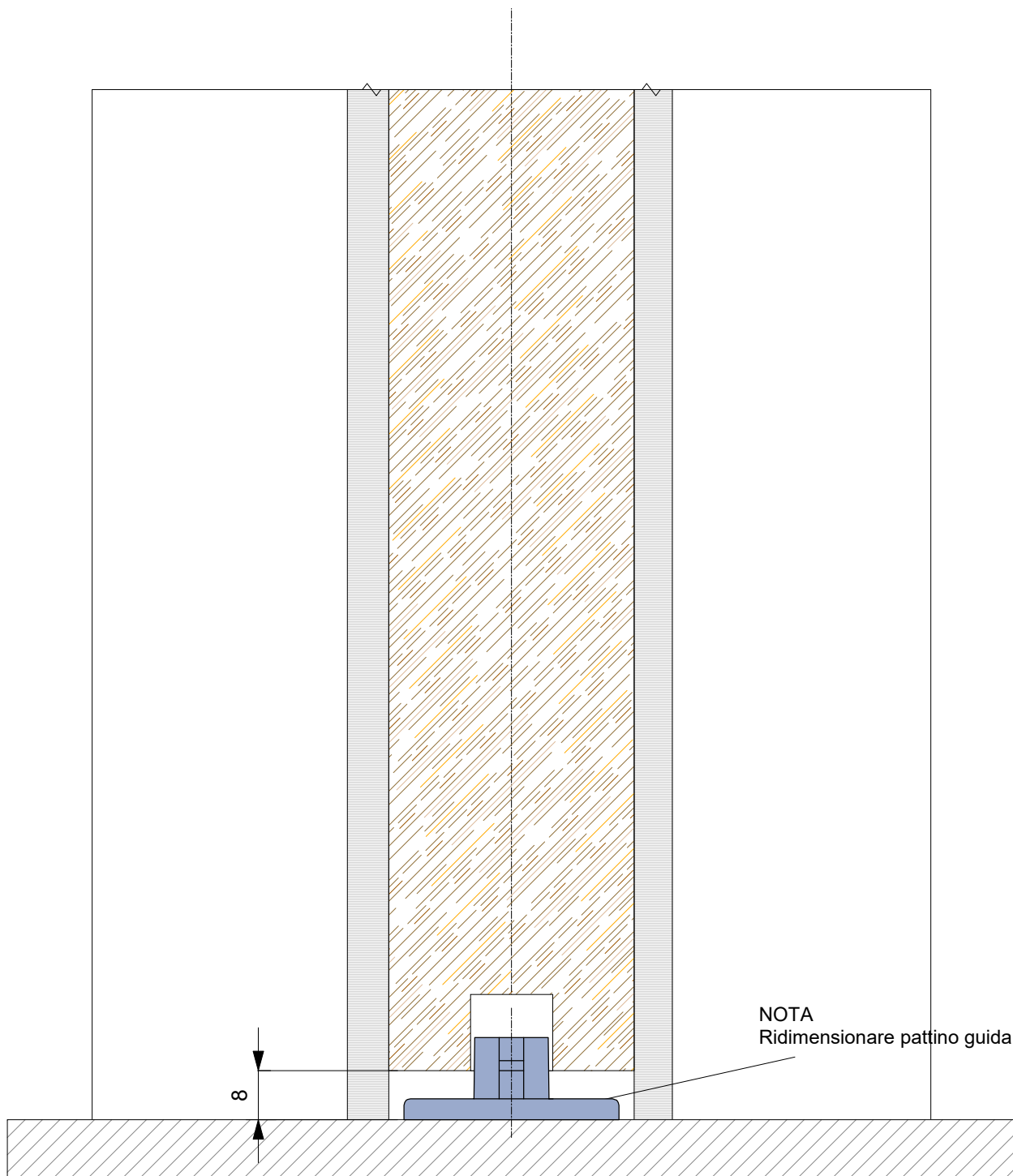
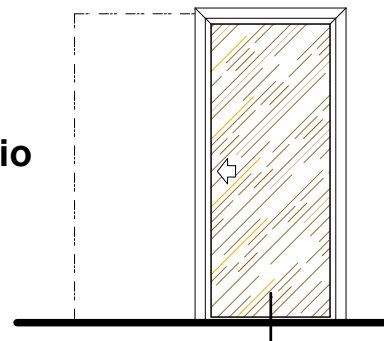



Porta a scomparsa scorrevole con control telaio "Scrinno Base 105" per intonaco

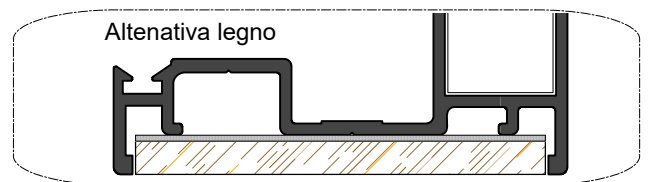
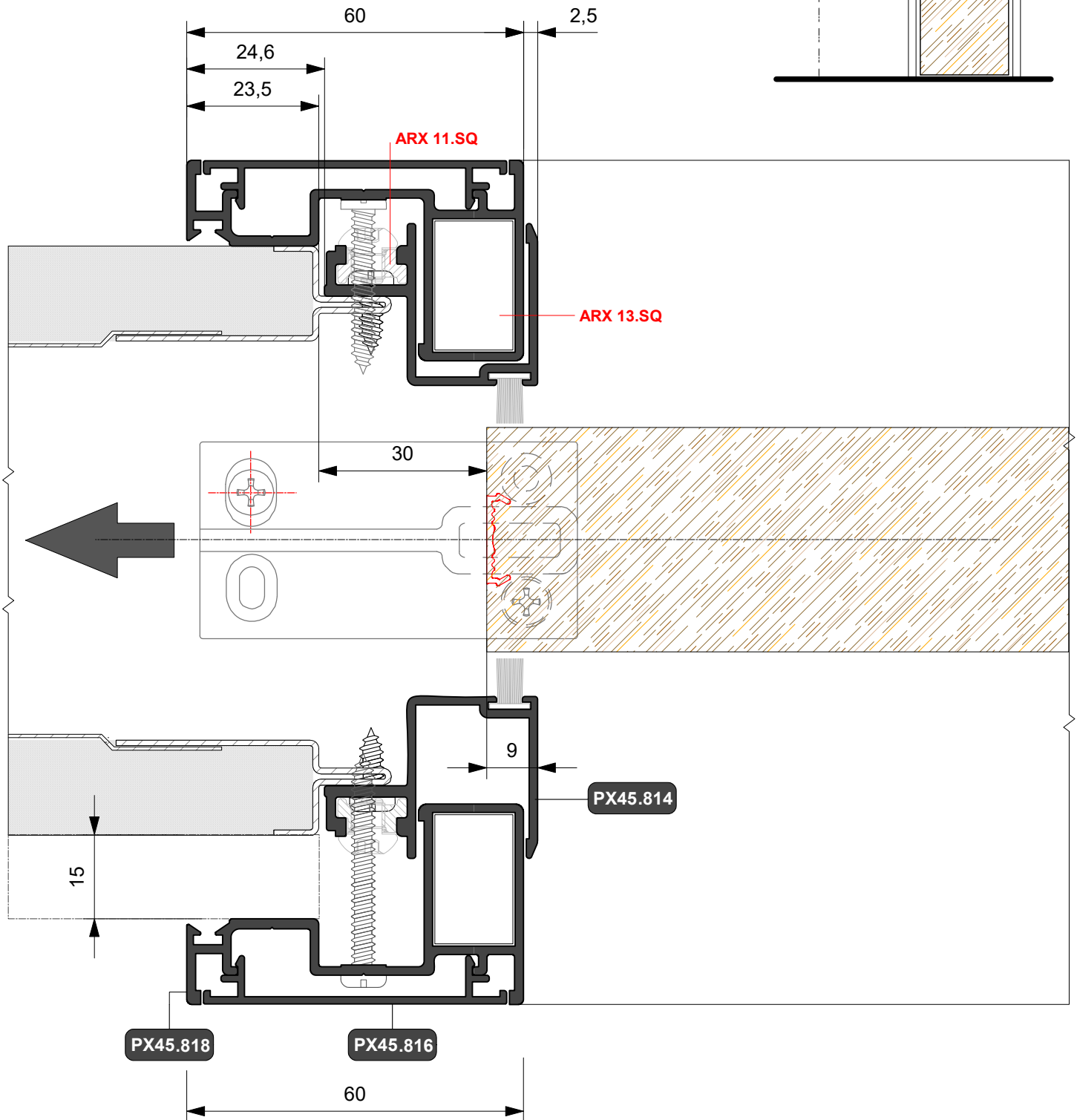
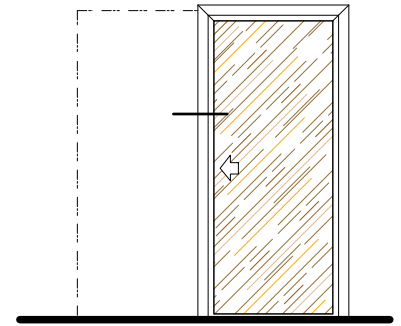



**Porta a scomparsa scorrevole con controteatro
"Scrigno Base 105" per intonaco**

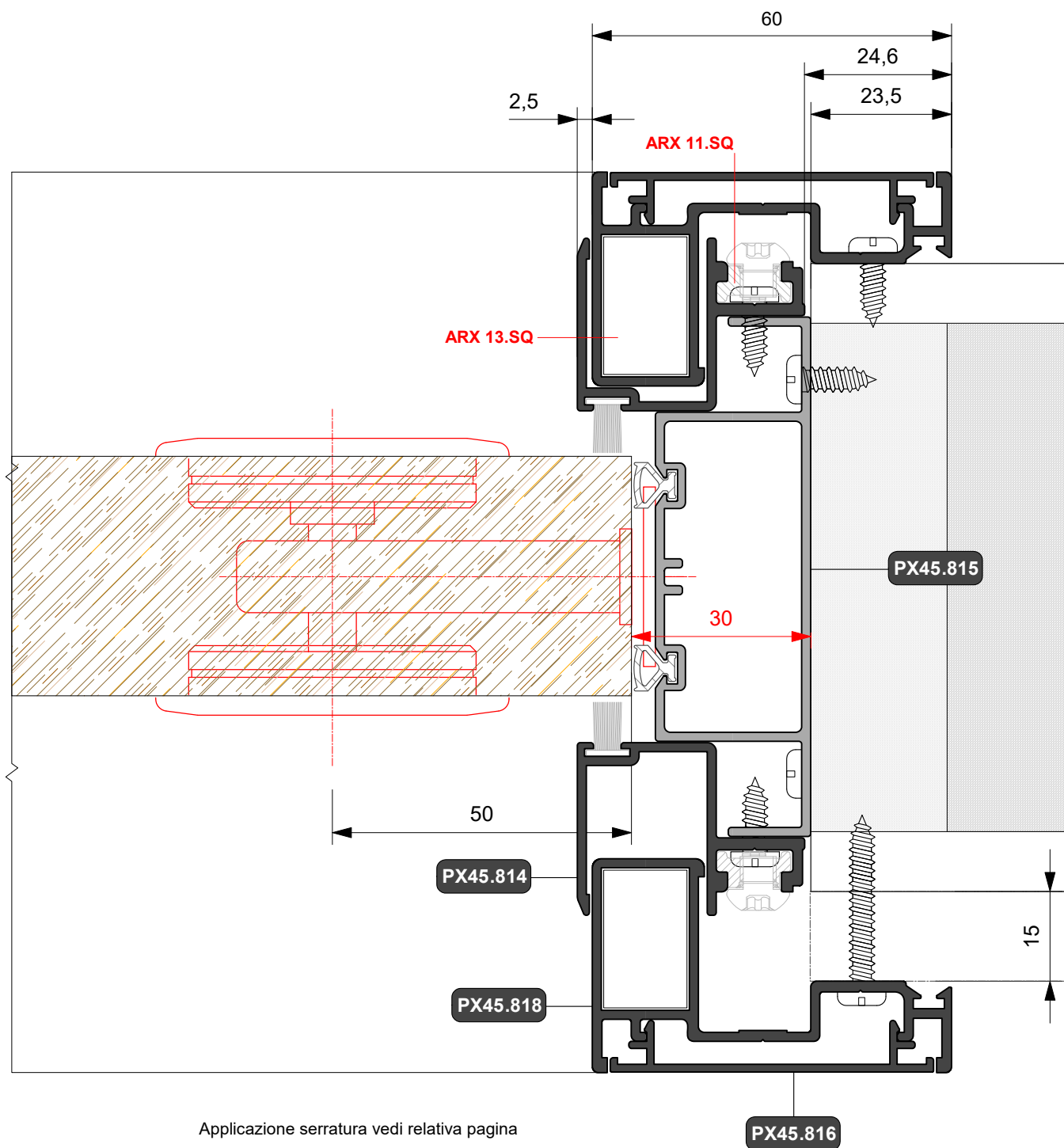
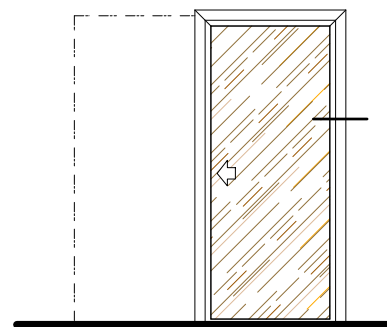



PORTA INTERNA
con anta in legno

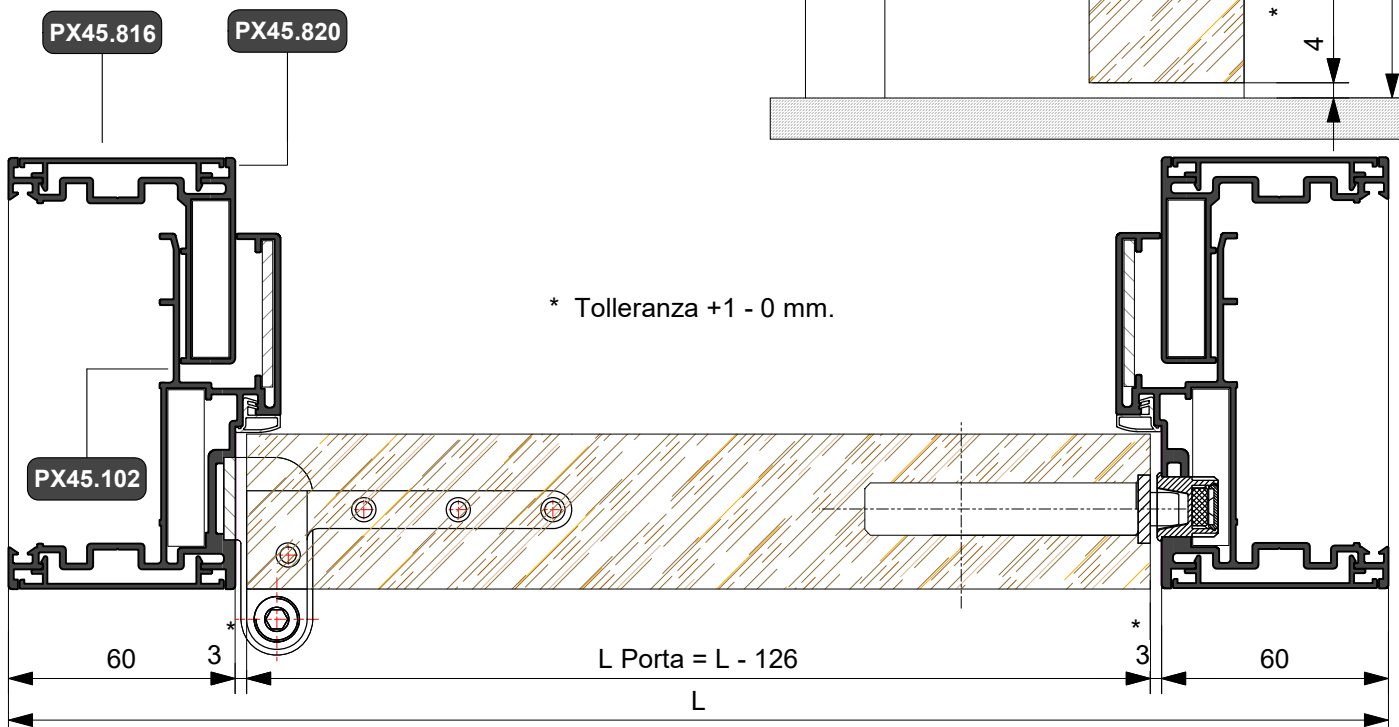
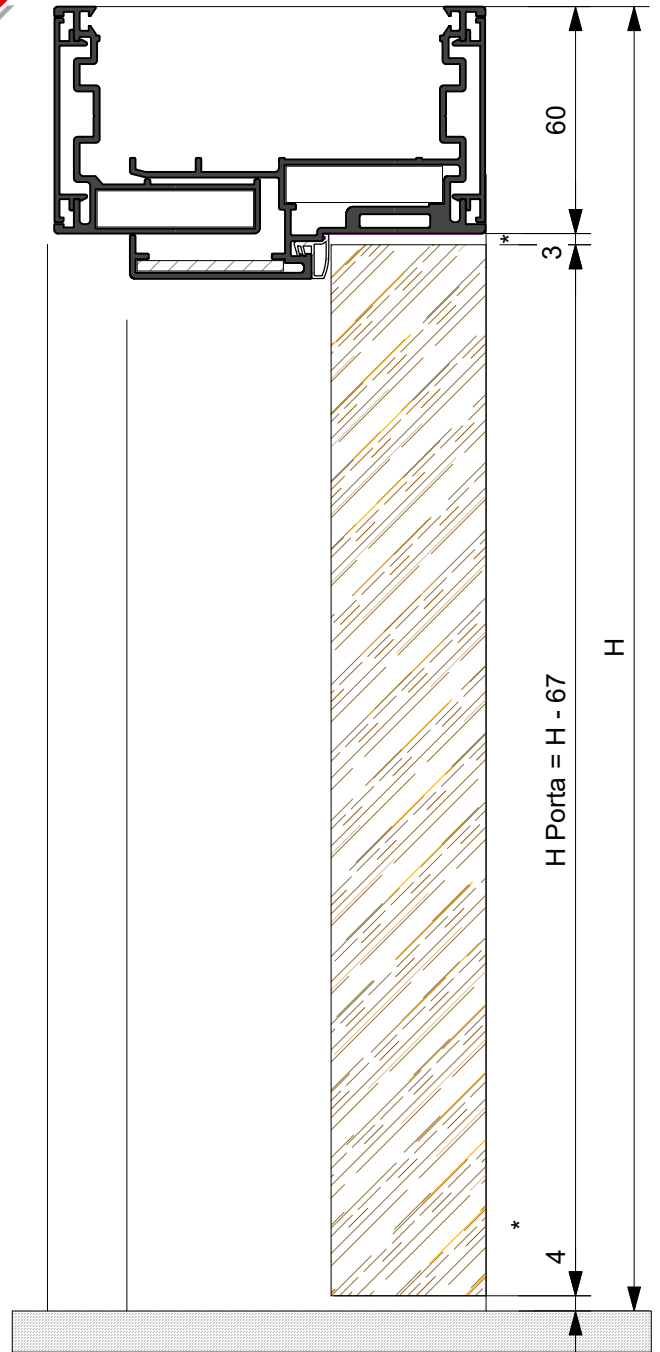
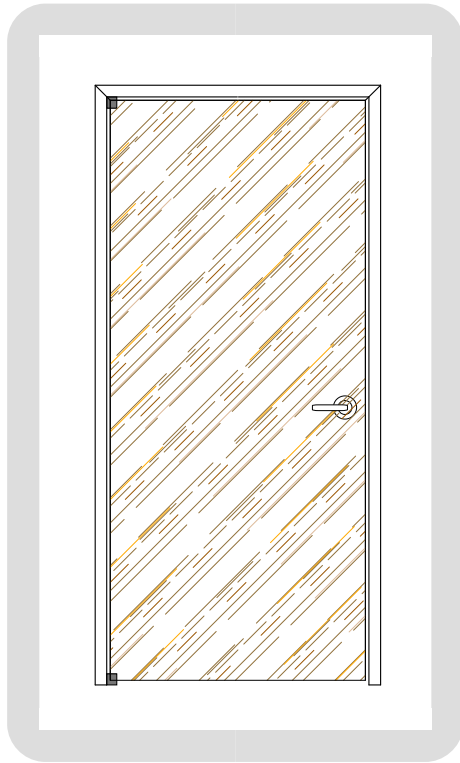



PORTA INTERNA
con anta in vetro

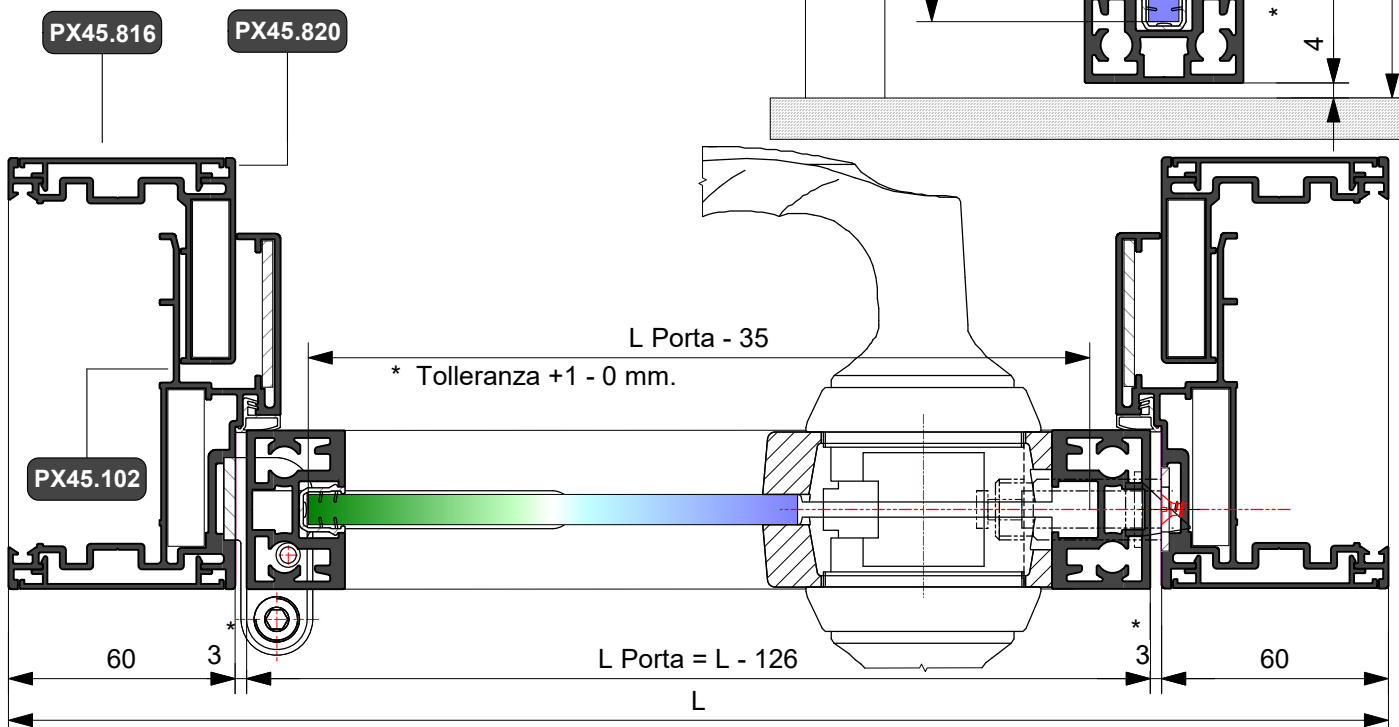
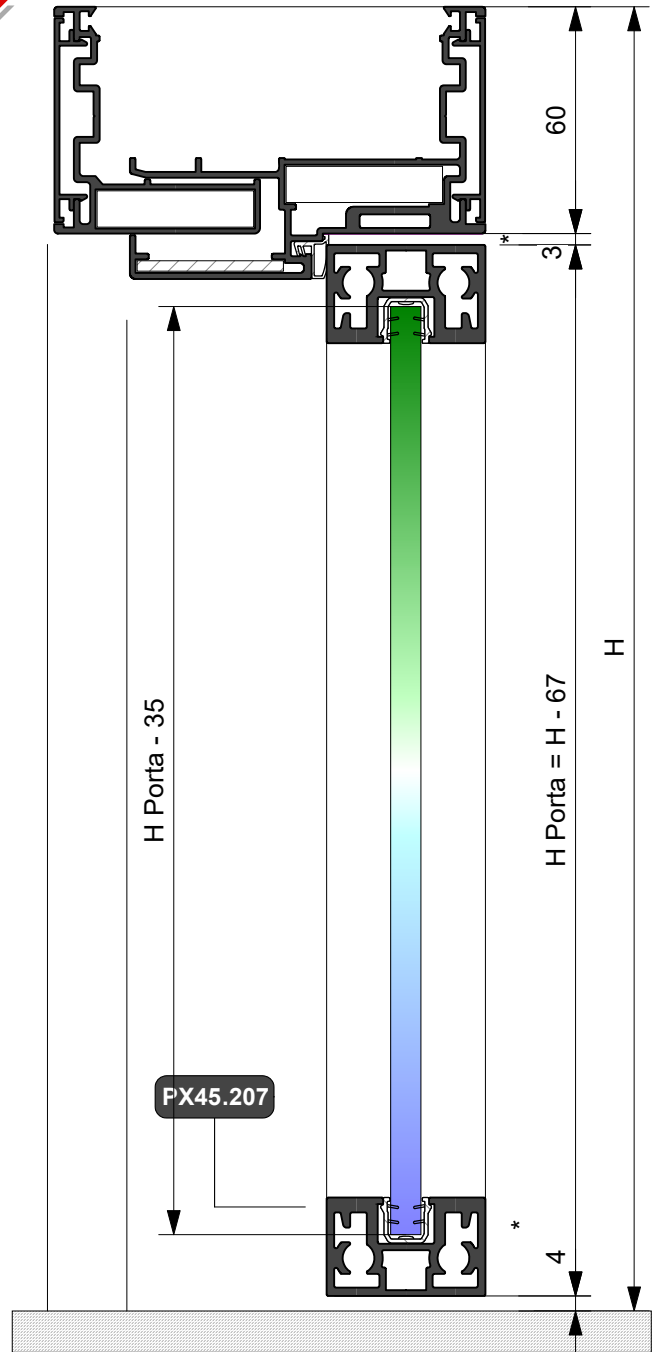
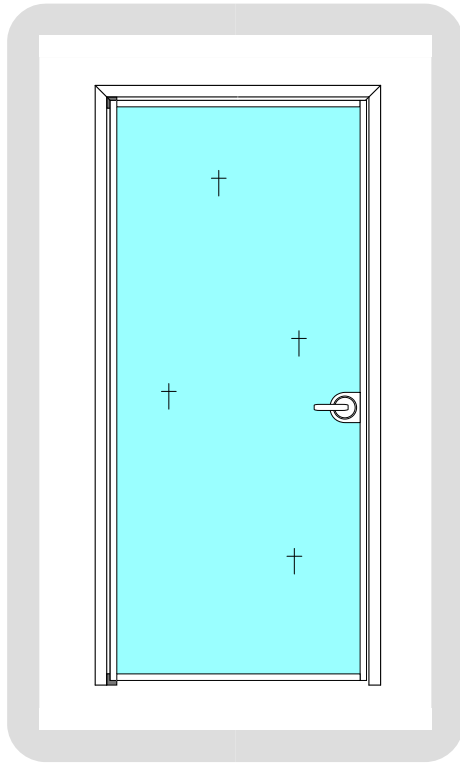



PORTA INTERNA
con anta in vetro

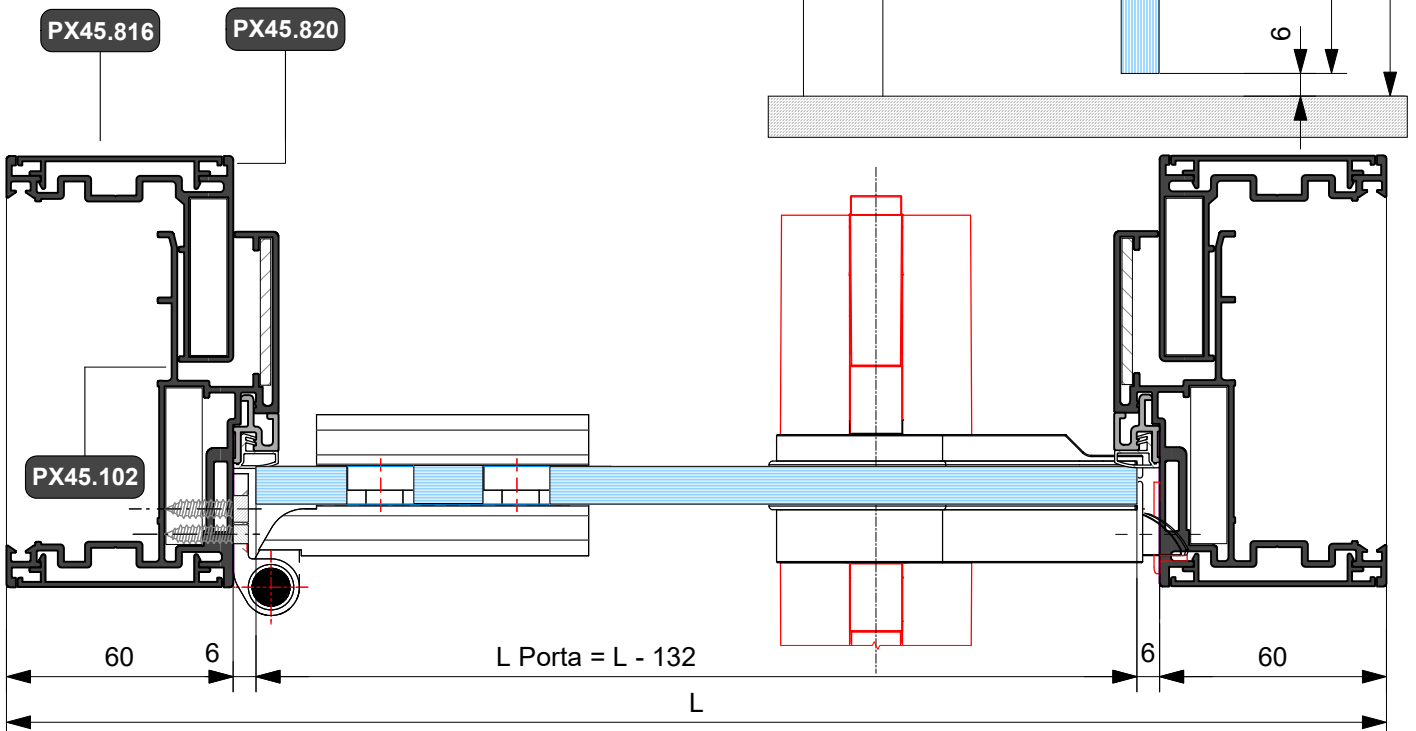
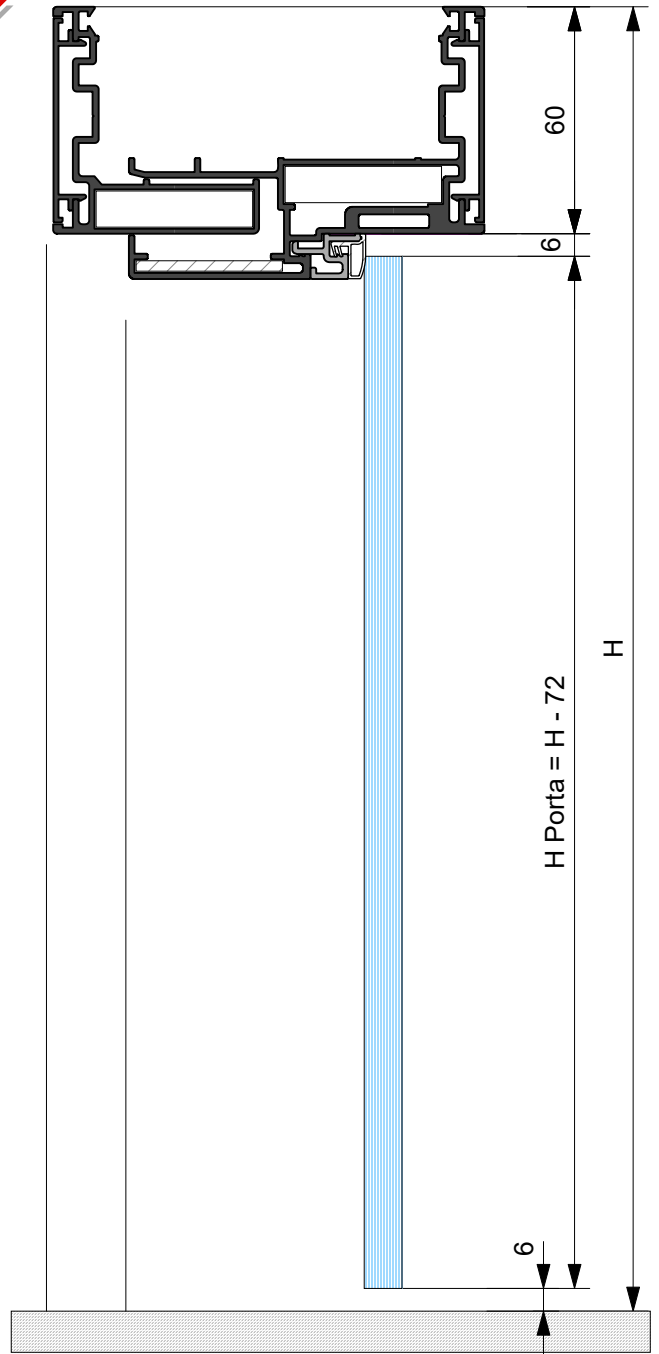
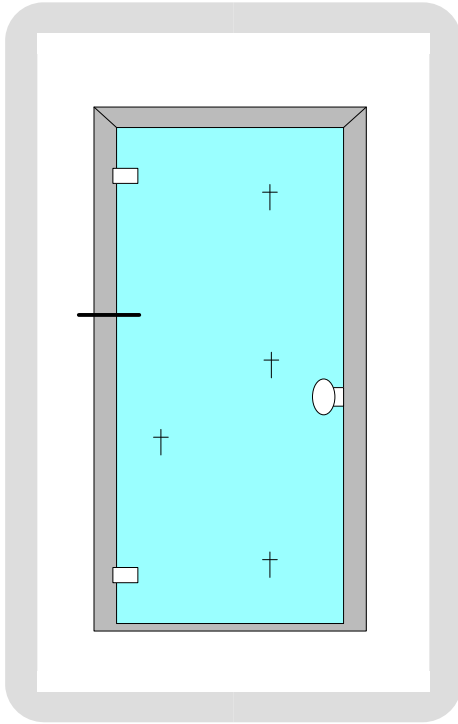



Porta a scomparsa scorrevole

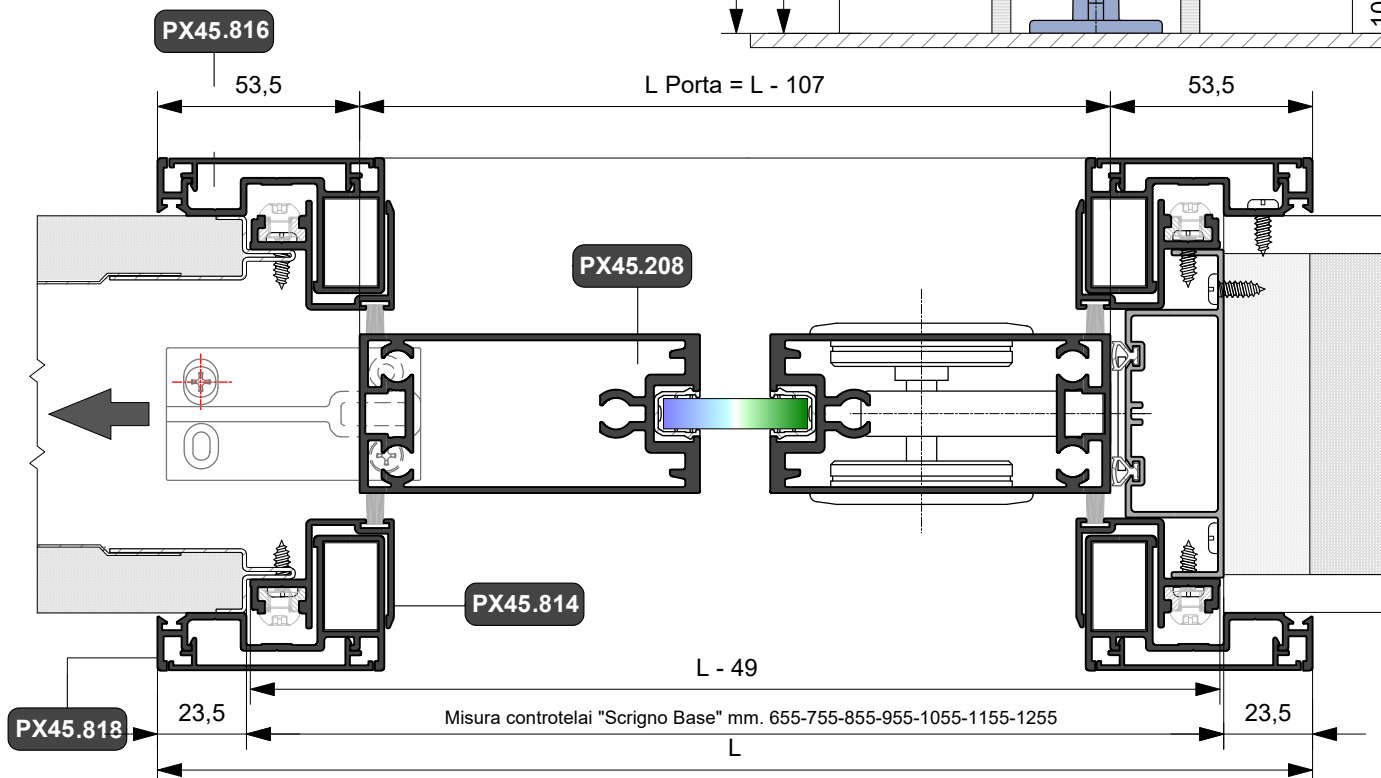
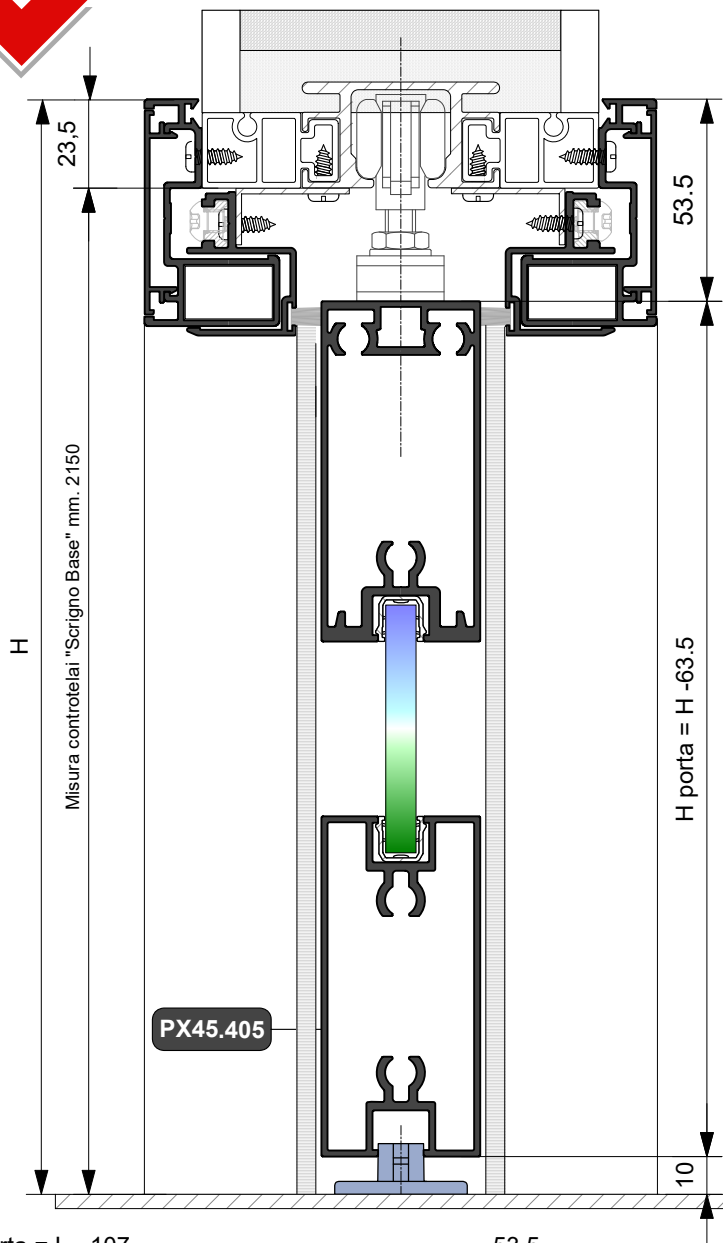
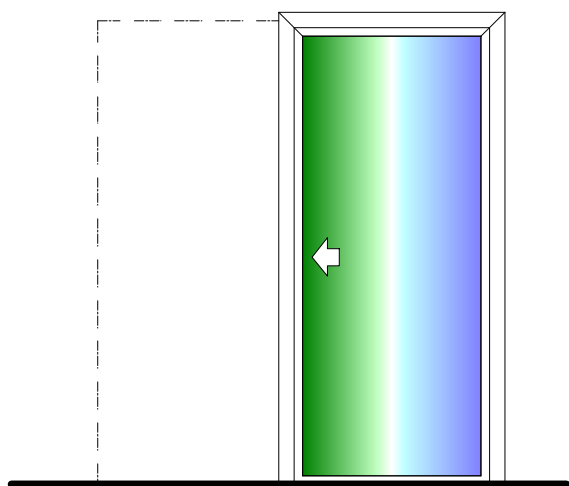

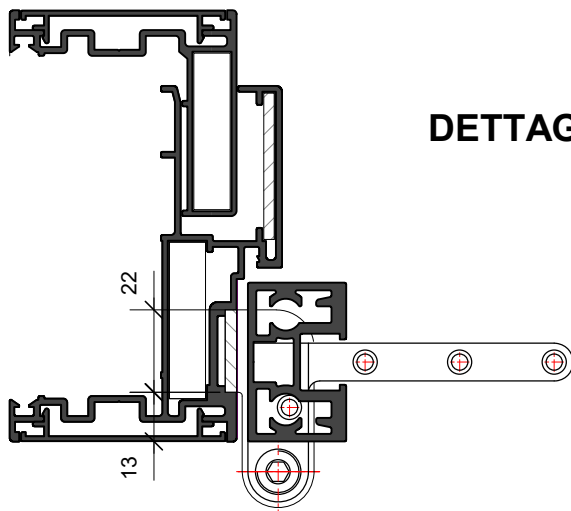
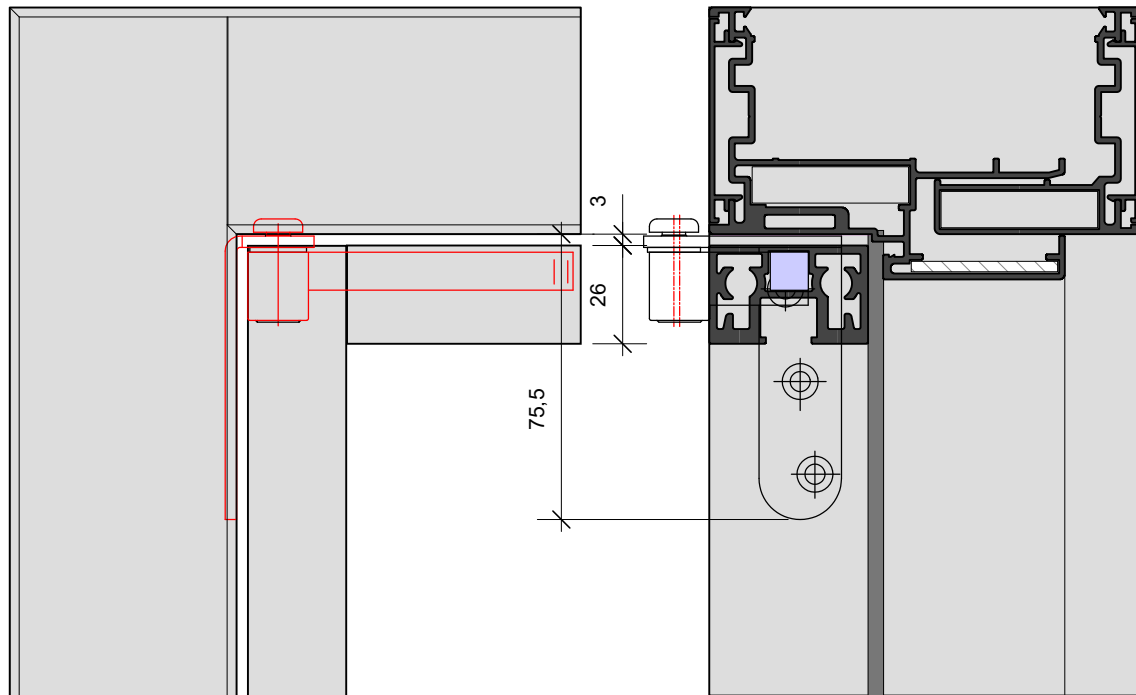

DETTAGLI ASSIEME

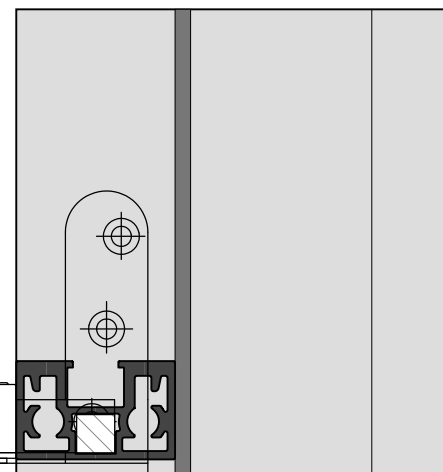
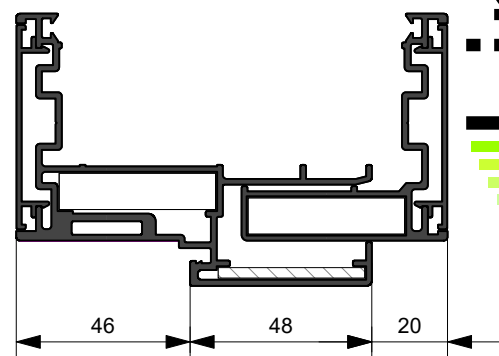
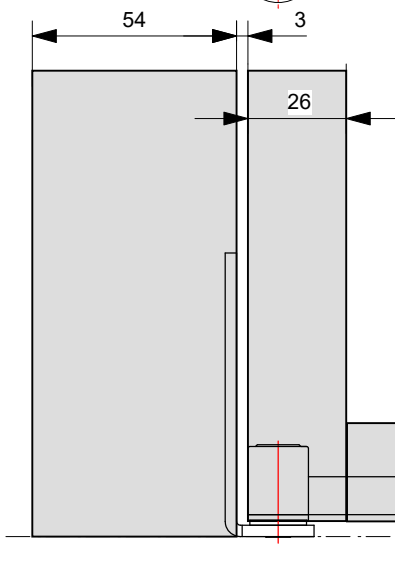

Linear



Linear

Lavorazioni anta

APX.02.06

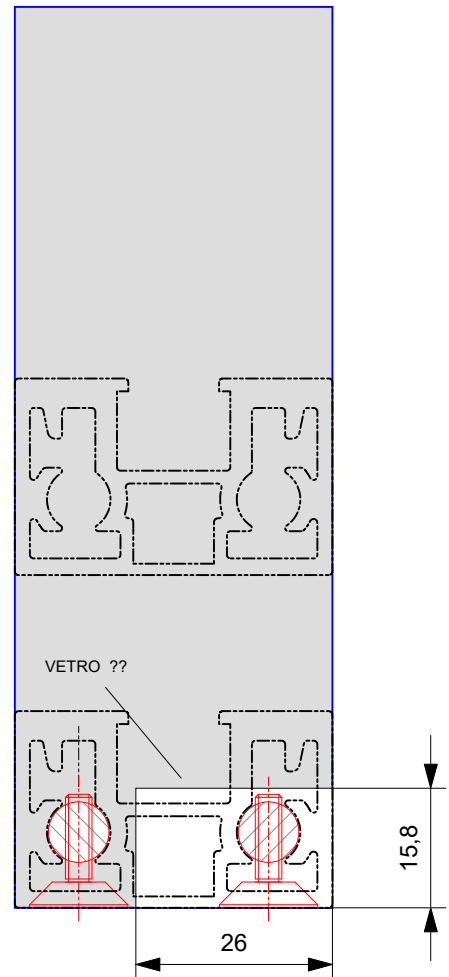
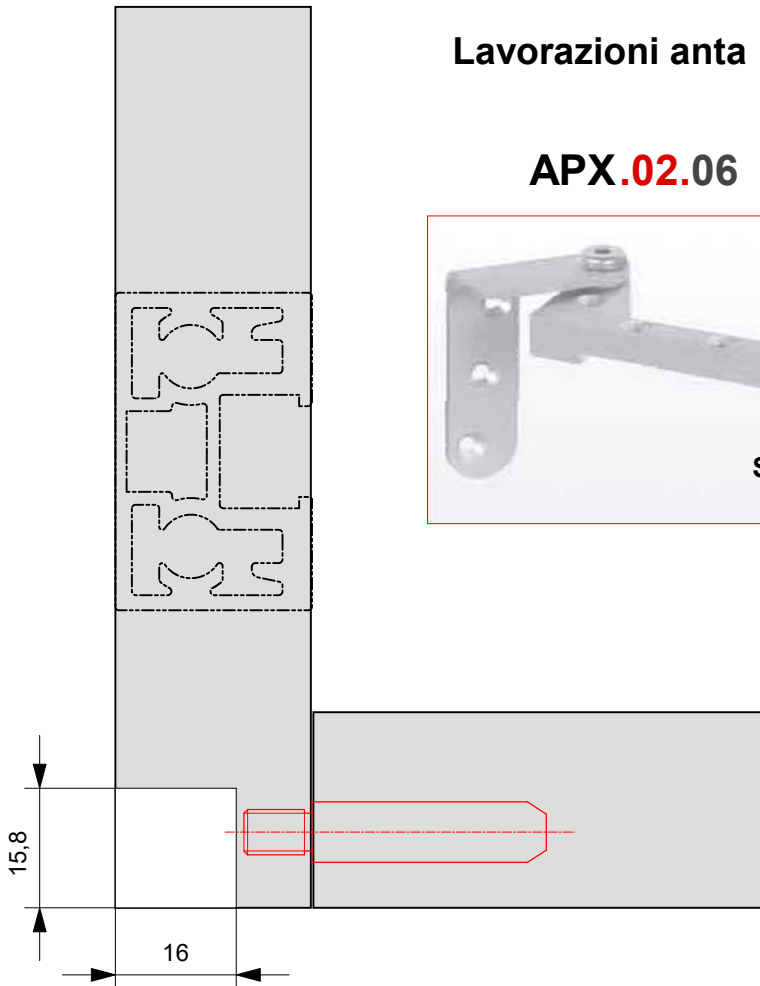

APX.31.SQ

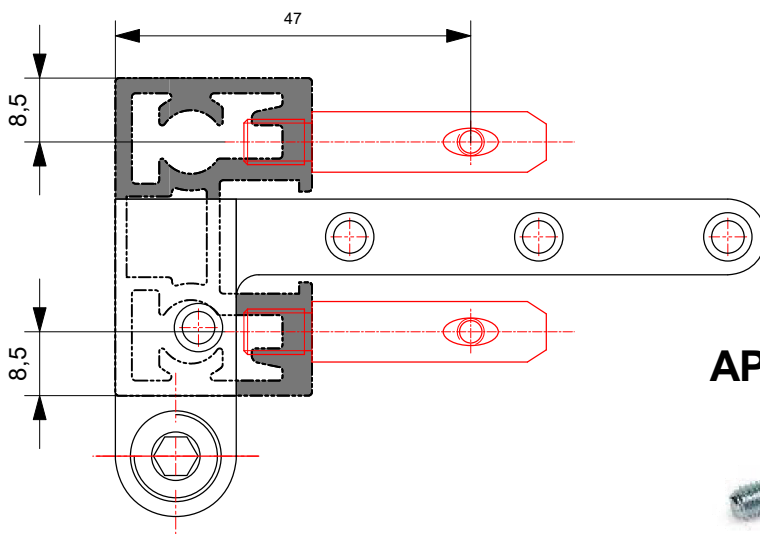

APX.30.SQ





Linear

Lavorazioni anta

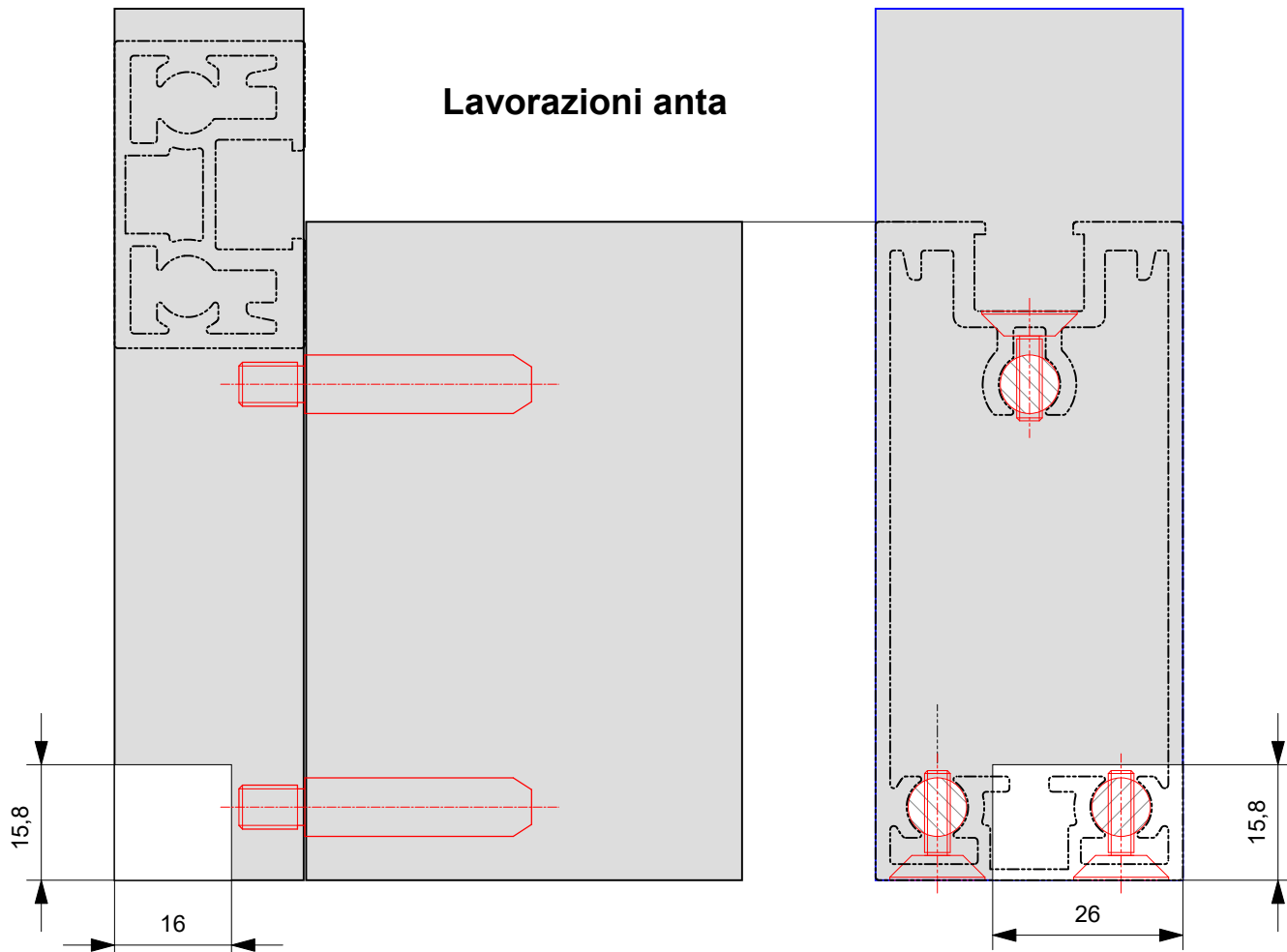

APX.31.SQ

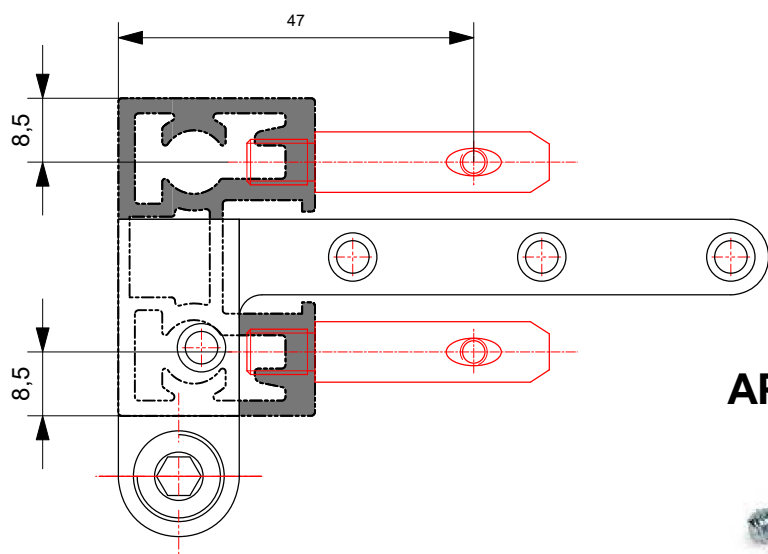

APX.30.SQ





Linear

Lavorazioni anta

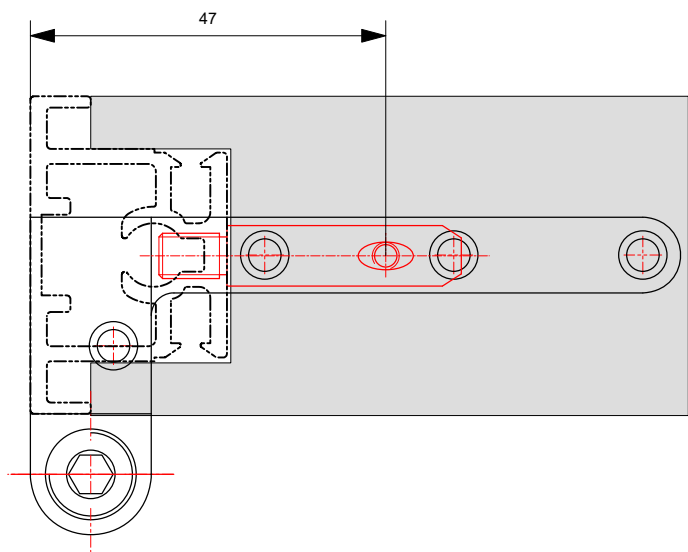
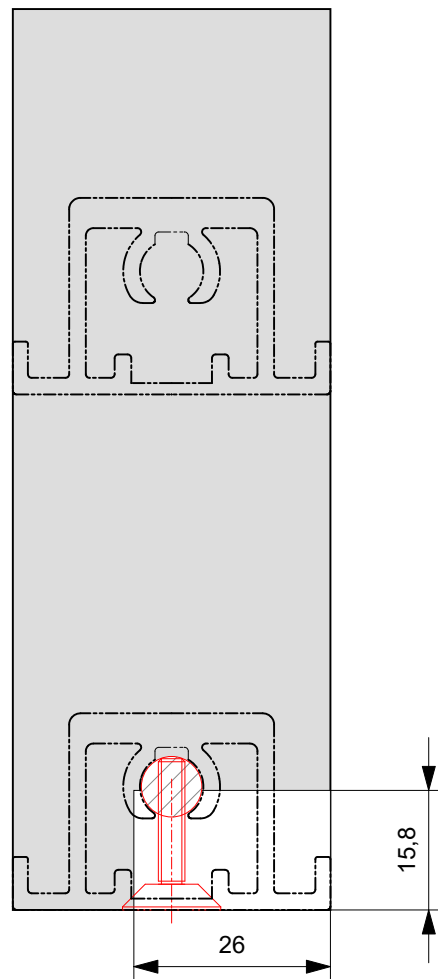
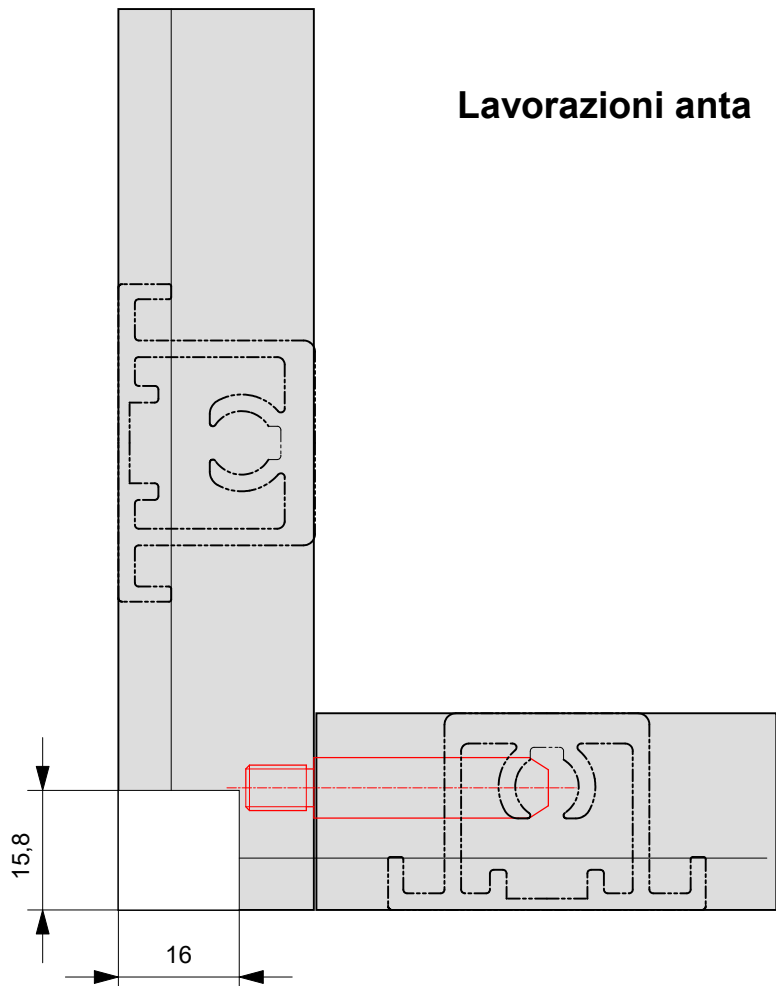

APX.31.SQ



APX.30.SQ



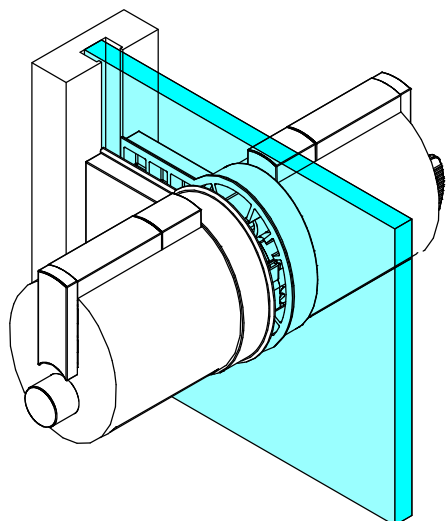

APX.03.14

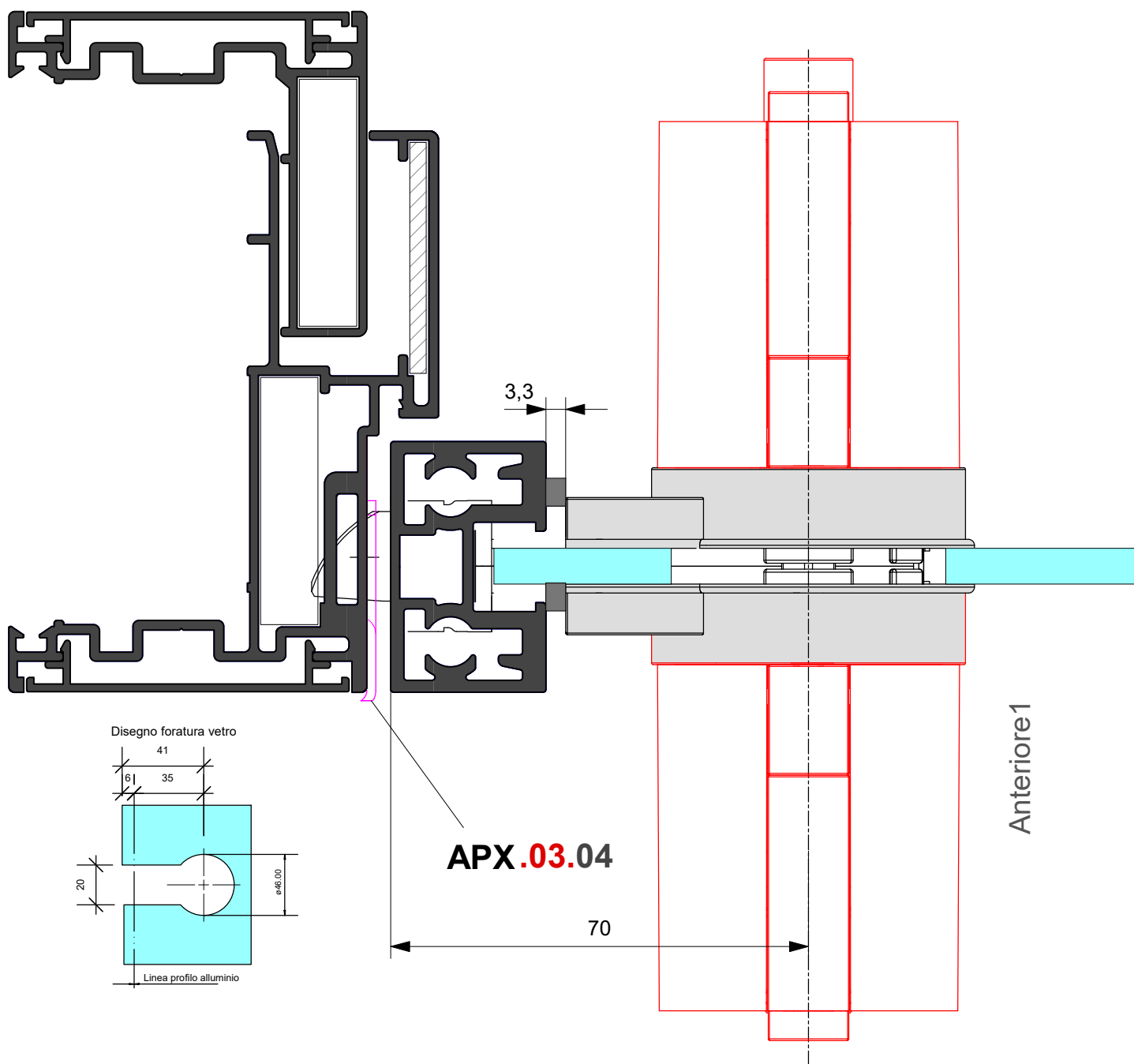

APX.03.04

Anteriore1



Applicazione serratura su porta scorrevole a scomparsa

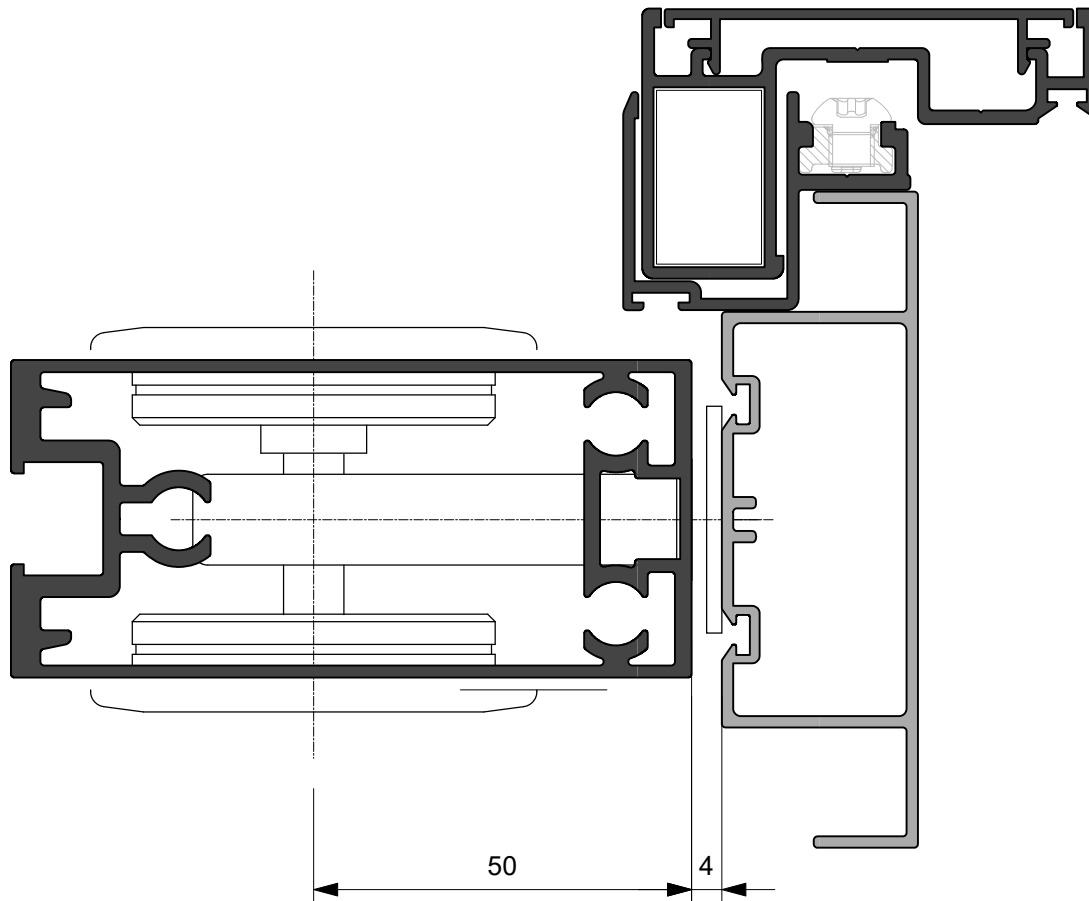

Riferimenti **AGB**

Serratura E= 50 mm		Kit A
		<p>Art.</p> <p>SCIVOLA TT</p>

PAM SYSTEM S.r.l.
13030 Formigliana (VC)
S.S. 230 - Fornace Crocicchio
Tel. 0161 858811 - Fax 0161 858800
www.pamsystemsrl.com - info@pamsystemsrl.com

S.A.F. S.r.l.
Via Bonati, 21 - 29017 Fiorenzuola D'Arda (PC)
Tel. 0523 943228 - Fax 0523 941127
info@saf-srl.com

PAESANI S.r.l.
Via Emilia, 41 - 47921 Rimini
Tel. 0541 748511 - Fax 0541 741208
www.paesani.com - info@paesani.com

ALUK GROUP CENTRO DI FIRENZE
Piani della Rugginosa, 203/206
Tel. 055 8662351/352 - Fax 055 8662065
55066 Reggello (FI)

DI.VA S.r.l.
Via Po, 25 - Z. I. Sambuceto
66020 San Giovanni Teatino (CH)
Tel. 085 4405210 - Fax 085 4405207
www.camel-diva.com - info@camel-diva.com

EUROALL S.r.l.
Str. Comunale della Mola Saracena, 23
00065 Fiano Romano (RM)
Tel. 0765 455228/61 - Fax 0765 455317
info@euroallsl.it

06083 Bastia Umbra (PG)
Tel. 075 8012385-075 8010328 - Fax 075 8012386
profilatumbria@virgilio.it

OSSIDAL INTERNATIONAL ITALIA S.r.l.
Via di Torre Spaccata, 172 - 00169 Roma
Tel. 06 2251591 (Ric. Aut.) - Fax 06 2280693
info@ossidalinternational.com

ALLCAR SERVICE S.r.l.
Via Acuto, 120 - 00131 Roma
Tel. 06 4130626 (Ric. Aut.) - Fax 06 4130367
allcarservice@mcmlink.it

CARUSO S.r.l.
Z.I. Contrada Le Macere
86019 Vinchiatturo (CB)
Tel. 0874 340024 - Fax 0874 340025
carusosrl1@libero.it

ALLUCOM S.r.l.
Via Vecchia Barletta 237
Z. Ind. - 76123 Andria (BT)
Tel. 0883 592213 - Fax 0883 552386
www.allucom.com - info@allucom.com



«EPOPS»

SALENTO METALLI S.r.l.
Via Federico II, 13 - Zona PIP
73020 Cavallino (LE)
Tel. 0832 614576 - Fax 0832 614635
www.salentometalli.it - info@salentometalli.it

MIDA ALLUMINIO S.r.l.
Via Piano del Principe, 36
80047 San Giuseppe Vesuviano (NA)
Tel. 081 5297373 - Fax 081 8284449
www.midaalluminiogroup.it - info@gruppomida.it

MIDA ALLUMINIO S.r.l.
Loc. Terzerie - Z. Ind.
80061 Ogliastro Cilento (SA)
Tel. 0974 833233 - Fax 0974 844724
www.midaalluminiogroup.it - info@midaalluminiogroup.it

COMAS S.r.l.
Via Porta Palermo, 84 - 91011 Alcamo (TP)
Tel. 0924 507050 - Fax 0924 507051
www.comasgroup.it - info@comasgroup.it

ITALBACOLOR S.r.l.
C.da Valle S. Maria - 87020 Fuscaldo (CS)
Tel. 0982 618025 - Fax 0982 720235
www.italbacolor.it - info@italbacolor.it



Consorzio TWIN SYSTEMS
Via di Torre Spaccata, 172
00169 ROMA
Tel./Fax 06 23260298



info@twinsystems.it
www.twinsystems.it